

Архангельск (8182)63-90-72  
Астана (7172)727-132  
Астрахань (8512)99-46-04  
Барнаул (3852)73-04-60  
Белгород (4722)40-23-64  
Брянск (4832)59-03-52  
Владивосток (423)249-28-31  
Волгоград (844)278-03-48  
Вологда (8172)26-41-59  
Воронеж (473)204-51-73  
Екатеринбург (343)384-55-89  
Иваново (4932)77-34-06

Ижевск (3412)26-03-58  
Иркутск (395)279-98-46  
Казань (843)206-01-48  
Калининград (4012)72-03-81  
Калуга (4842)92-23-67  
Кемерово (3842)65-04-62  
Киров (8332)68-02-04  
Краснодар (861)203-40-90  
Красноярск (391)204-63-61  
Курск (4712)77-13-04  
Липецк (4742)52-20-81

Магнитогорск (3519)55-03-13  
Москва (495)268-04-70  
Мурманск (8152)59-64-93  
Набережные Челны (8552)20-53-41  
Нижний Новгород (831)429-08-12  
Новокузнецк (3843)20-46-81  
Новосибирск (383)227-86-73  
Омск (3812)21-46-40  
Орел (4862)44-53-42  
Оренбург (3532)37-68-04  
Пенза (8412)22-31-16

Пермь (342)205-81-47  
Ростов-на-Дону (863)308-18-15  
Рязань (4912)46-61-64  
Самара (846)206-03-16  
Санкт-Петербург (812)309-46-40  
Саратов (845)249-38-78  
Севастополь (8692)22-31-93  
Симферополь (3652)67-13-56  
Соленск (4812)29-41-54  
Сочи (862)225-72-31  
Ставрополь (8652)20-65-13

Сургут (3462)77-98-35  
Тверь (4822)63-31-35  
Томск (3822)98-41-53  
Тула (4872)74-02-29  
Тюмень (3452)66-21-18  
Ульяновск (8422)24-23-59  
Уфа (347)229-48-12  
Хабаровск (4212)92-98-04  
Челябинск (351)202-03-61  
Череповец (8202)49-02-64  
Ярославль (4852)69-52-93

Киргизия (996)312-96-26-47

Россия (495)268-04-70

Казахстан (772)734-952-31

<https://greetmed.nt-rt.ru> || [gdc@nt-rt.ru](mailto:gdc@nt-rt.ru)

## КАТАЛОГ НА ОДНОРАЗОВУЮ ПРОДУКЦИЮ





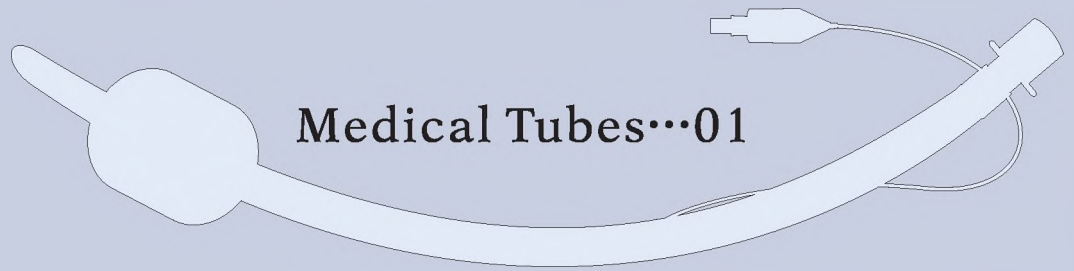

Medical Tubes...01

Hypodermic &  
Surgical Instruments...22

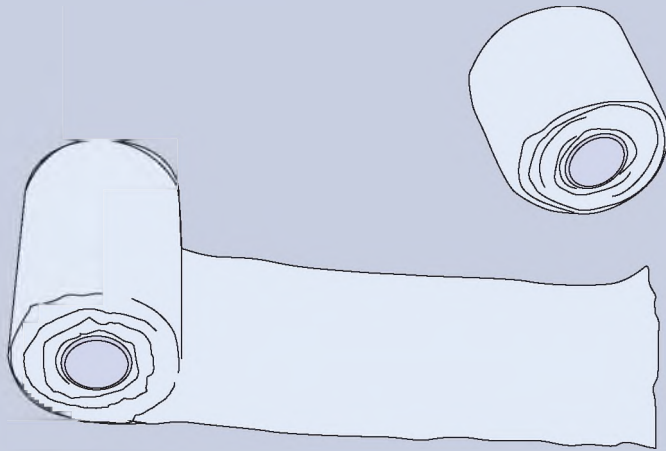
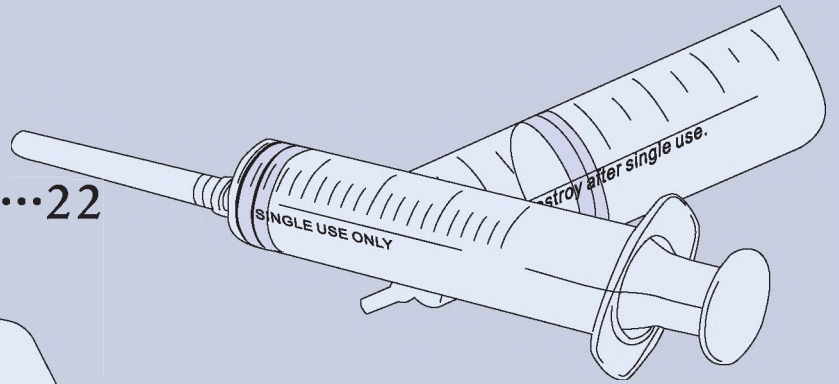

Wound Dressing...34

Disposable  
Hospital Uniform...52

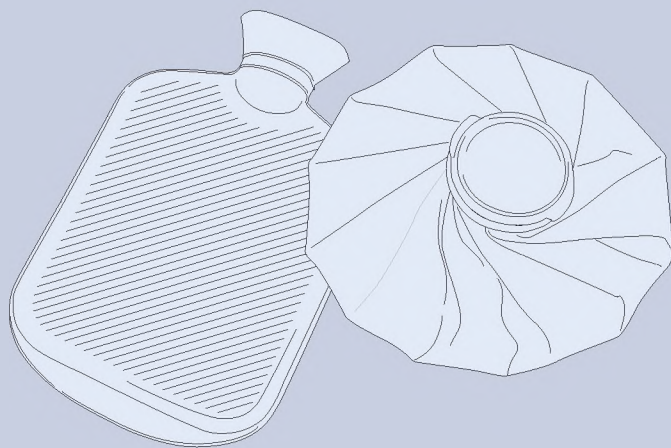
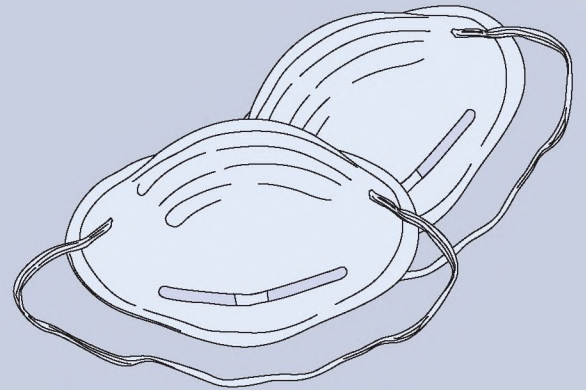

Other Medical Products...61

CONTENTS

CE Approved

# MEDICAL TUBES

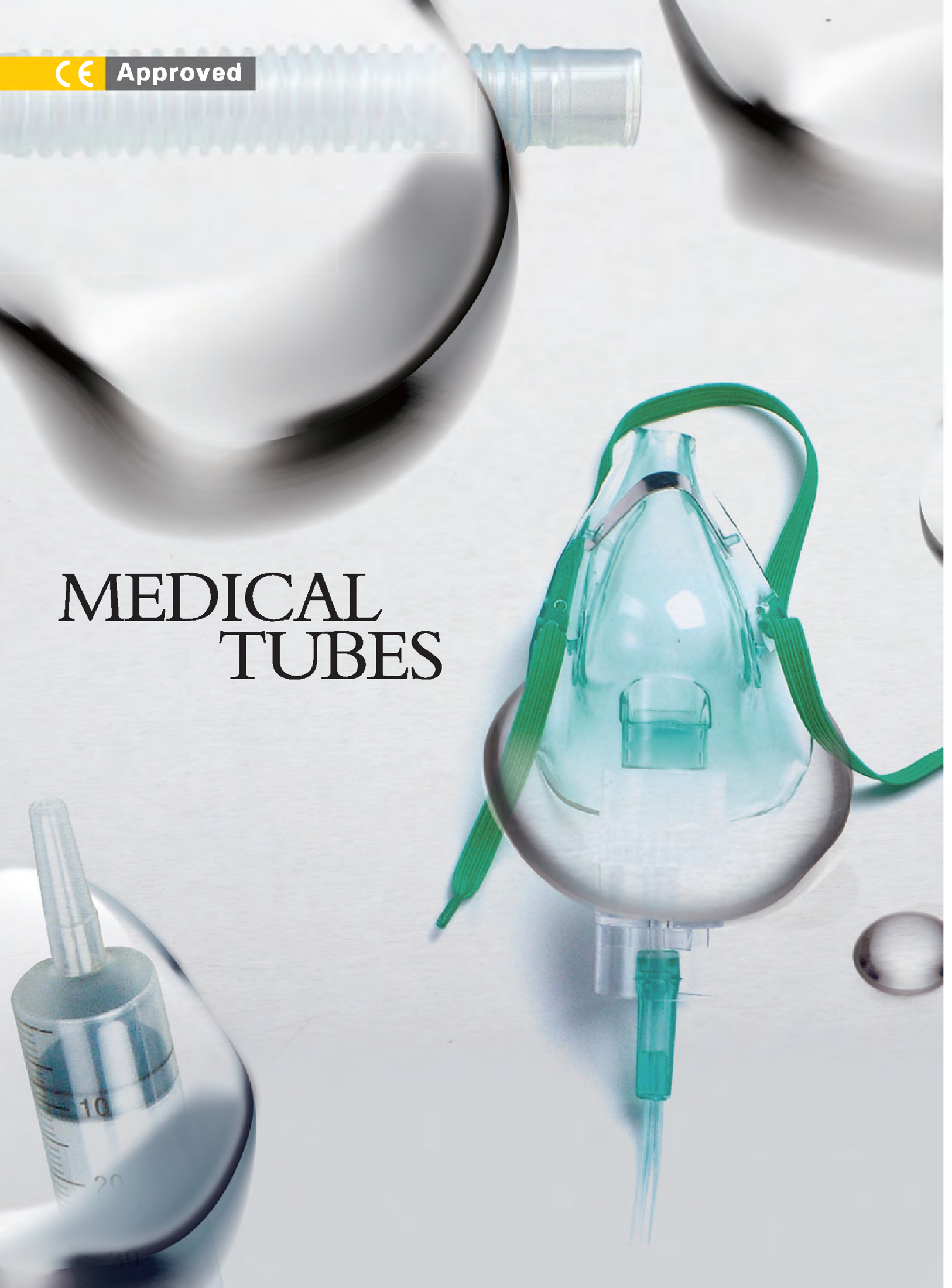



**GT010-110 Simple Oxygen Mask**

Made of medical grade PVC  
 With adjustable nose clip  
 With elastic strap  
 With 2m tubing  
 Size available: S, M, L, XL  
 Packed in individual PE Bag  
 100pcs/ctn, Dimension: 47X39X26cm



**GT010-150 Venturi mask**

Made of medical grade PVC  
 With adjustable nose clip  
 With elastic strap  
 Venturi valve: blue 24%, yellow 28%, white 31%,  
 green 35%, pink 40%, orange 50%  
 With 2m tubing  
 Sizes available: S, M, L, XL  
 Packed in individual PE Bag  
 50pcs/ctn, Dimension: 45X36X20cm



**GT010-120 Tracheostomy Mask**

Made of medical grade PVC  
 Flexible plastic mask with elastic head strap  
 With 360 angle rotation connector  
 Excellent compatible with corrugated tubing  
 & other connection device  
 Sizes available: Adult and Children  
 Packed in individual PE Bag  
 100pcs/ctn, Dimension: 48X36X28cm



**GT012-100 Nebulizer Mask**

Made of medical grade PVC  
 With adjustable nose clip  
 With Elastic Strap  
 With 2m tubing  
 Sizes available: S, M, L, XL  
 Packed in individual PE Bag  
 50pcs/ctn, Dimension: 49X28X24cm



**GT012-200 Nebulizer with Mouth piece**

Made of medical grade PVC  
 Used with any of the compressor/nebulizers for treatment  
 of asthmatic patients.  
 Designed for comfortable administration of fine mists  
 of uniform density to reach deep into lung cavity.  
 Simple three-piece design is easy to assemble and clean  
 Break-resistant plastic provides the patient with 14 days of use  
 With 15cm corrugated tube  
 With 2M tubing  
 With T-piece and mouthpiece.  
 Packed in individual PE Bag  
 50pcs/ctn, Dimension: 49X28X22cm

### GT010-160

#### Oxygen Mask with Reservoir bag

Made of medical grade PVC  
 Reservoir bay with/without check valve  
 One safety vent open.  
 Mask with elastic strap,  
 Adjustable nose clip  
 Non-rebreathing Mask provides a high concentration of oxygen with 2m tubing,  
 Size available: S, M, L, XL  
 Packed in individual PE Bag  
 100pcs/ctn, Dimension: 47X39X25cm



### GT013-100 Nasal Oxygen Cannula

Made of medical grade PVC,  
 Straight Tip, Flared Tip and Curved Tip is available.  
 With 2M tubing  
 Size available: S, M, L, XL  
 Packed in individual PE Bag  
 100pcs/ctn, Dimension: 45X38X20cm

#### GT013-200 Soft tip

With 2m oxygen tubing



### GT027-100

#### Connecting Tube with Yankauer Handle

Made from non-toxic PVC, clear and soft  
 Large lumen resists clogging and the transparency allows clear visualization of liquids  
 Crown tip, vented.  
 With connecting tube  
 Size: 1/4"X1.8m, 1/4"X3.6m, 3/16"X1.8m, 3/16"X3.6m  
 Packed in individual Blister Bag or Poly Bag  
 20pcs/ctn, Dimension: 38X30X25cm

### GT027-200

#### Suction Poole Draining Tube

with 2.1 meter Length, Sterile



### GT032-100

#### Anaesthesia breathing system

##### Specification:

adult/pediatrics; common/extension tube  
 Construction: with L connector, three-way connector, breath air chamber, solenoid  
 Function: connect the equipment, transfer the air to body  
 Store claim: store in dark, dry and clean conditions, do not give heavy press  
 Form of packing: 30set/carton  
 Size of packing:  
 Export carton: 660x480x375mm  
 GW:5.8kgs



### GT032-200

Bacterial/Viral filter  
 Parts:Shell membrane  
 Material:styrene butadiene copolymer, hydrophobic polypropylene  
 250pcs/60x50x50cm  
 8kgs/7.5kgs



### GT032-300

#### Breathing system filter

Efficiency: 99.99%  
 Humidification rate: 99.9%  
 Temperature output: 30°C(at 500ml TV)  
 Resistance: ≤ 0.2kpa(at 30L/min)



GT011-100



GT011-200

### Teeth Cushion

### Teeth Cushion

purpose: A fixture to protect the lips and mouth of patient, and to observe the throat.

The fixture can be attached on theraputic equipment.

**GT011-100** Type III (Gastroscope Fixture),  
 packing: 1pc/blister pack, 10pcs/bag, 500pcs/ctn, 50x35x35cm

**GT011-200** Type I (Airway)  
 packing: 1pc/blister pack, 10pcs/bag, 500pcs/ctn, 50x35x35cm

Raw material: polyethylene  
 Sterilization: EO

## GT012-400 Anesthesia Mask

Made from non-toxic PVC

100% Latex-free

Complying with biocompatibility standards, Soft air cushion ensures flexibility, air tightness and low odor. The mask is specially designed to fit comfortably on a patient's face. This device can be used in connection with medical equipment such as anaesthetic apparatus, ventilators, oxygen machines, hyperbaric oxygen stores, inhaled painless delivery instruments, and emergency breathing apparatus.

Packed in a individual PE bag

Size available:

1 #	240pcs/ctn,	Dimension: 46 X 41 X 32 cm
2 #,	240pcs/ctn,	Dimension: 46 X 41 X 32 cm
3 #,	120pcs/ctn,	Dimension: 46 X 41 X 38 cm
4 #,	120pcs/ctn,	Dimension: 46 X 41 X 38 cm
5 #,	140pcs/ctn,	Dimension: 57.5 X 48 X 46 cm
6 #,	100pcs/ctn,	Dimension: 57.5 X 48 X 46 cm



## GT012-300A type Silicone Resuscitator

**Intended use:** Silicone resuscitator is intended for pulmonary resuscitation.

GT012-300A, Adult: Adults and children.

GT012-300A, Pediatric: Children and infants.

GT012-300A, Infant: Infants and neonates.

**Features:**

Silicone resuscitator (except mask, oxygen tubing and reservoir bag) can be autoclaved repeatedly at 134°C.

It is equipped with a pressure limitation valve for Patient safety.

Its feature is a textured surface ensuring a firm grip and providing effective ventilation.

Patient connector is 22/15 mm (ISO5356-1).

100% latex free.

**Silicone resuscitator conforms to the standard:**

ISO 10651-4:2002, and it also conforms to Council Directive MDD/93/42/EEC concerning Medical Devices.



## GT012-300B type SEBS Resuscitator

**Intended use:** The SEBS resuscitator is disposable and intended for pulmonary resuscitation.

GT012-300B, Adult: Adults and children.

GT012-300B, Pediatric: Children and infants.

GT012-300B, Infant: Infants and neonates.

**Features:**

Due to being disposable, it can eliminate the possibility of cross-contamination.

Any cleaning, disinfecting or sterilizing is not necessary for it.

It is equipped with a pressure limitation valve for patient's safety.

Its textured surface ensures a firm grip and providing effective ventilation.

Patient connector is 22/15 mm (ISO5356-1).

The resuscitator bag is made from SEBS (Thermoplastic Elastomer) and is fully disposable.

100% latex free.

**The SEBS resuscitator conforms to the standard:**

ISO 10651-4:2002; and it also conforms to Council Directive MDD/93/42/EEC concerning Medical Devices.



## GT012-300C type PVC Resuscitator

**Intended use:** The PVC resuscitator is disposable and intended for pulmonary resuscitation.

GT012-300C, Adult: Adults and children.

GT012-300C, Pediatric: Children and infants.

GT012-300C, Infant: Infants and neonates.

**Features:**

Due to being disposable, it can eliminate the possibility of cross-contamination.

Any cleaning, disinfecting or sterilizing is not necessary for it.

It is equipped with a pressure limitation valve for patient's safety.

Its textured surface ensures a firm grip and providing effective ventilation.

Patient connector is 22/15 mm (ISO5356-1).

The resuscitator bag is made from PVC and is fully disposable. 100% latex free.

**The PVC resuscitator conforms to the standard:**

ISO 10651-4:2002; and it also conforms to Council Directive MDD/93/42/EEC concerning Medical Devices.





**GT029-700**

**Disposable Silicone Laryngeal Mask**

The tube is made from 100% Silicone,  
No poison and harmless  
Suitable for adult, children and infant use  
Type: 1.0, 1 1/2, 2.0, 2 1/2, 3.0, 4.0, 5.0  
Sterilization: EO  
Form of packing: 1pc/box, 20pcs/carton  
Measurement of carton: 400x360x315mm



**GT029-710**

**Reusable Silicone Laryngeal Mask**

The tube is made from 100% silicone,  
non-toxic and harmless  
Suitable for adult, children and infant use  
Type: 1.0, 1 1/2, 2.0, 2 1/2, 3.0, 4.0, 5.0  
Sterilization: EO  
Form of packing: 1pc/box, 20pcs/carton  
Measurement of carton: 400x360x315mm



**GT029-720**

**Disposable PVC Laryngeal Mask**

The tube is made from non-toxic PVC,  
No poison and harmless  
Suitable for adult, children and infant use  
Type: 1.0, 1 1/2, 2.0, 2 1/2, 3.0, 4.0, 5.0  
Sterilization: EO  
Form of packing: 1pc/box, 20pcs/carton  
Measurement of carton: 400x360x315mm

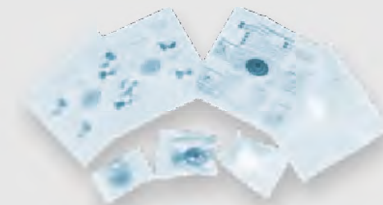

**GT117-100**

**Breathing Mask With One-way Valve**

A, 1pc/bag, 100bags/big Bag, 10big Bag/ctn, 32 X 44 X 38cm  
B, 1pc/bag, 100bags/big Bag, 10big Bag/ctn, 58 X 46 X 46cm



**GT117-300 CPR Mask**

Material: Latex-free  
Contents:  
Foldable Cushion Mask With Oxygen Port,  
One-way Valve,  
Disposable Filter, Elastic Head Strap  
Function : The Cpr Mask Is Designed To Provide Protection  
For Rescuer When Manually Resuscitating  
Patients. It Used By Adults, Children And Infants.  
**Storage:**  
Always Keep Mask In Storage Case When Not In Use.  
Storage Temperature: -45°C ~ 71°C  
Storage Relative Humidity: <85%  
Specifications:  
Dimensions: (122mm X 106mm X 46mm)  
Expiratory Resistance: 2.0 CmH<sub>2</sub>O ( at 50 L/min )  
Inspiratory Resistance: 3.5 CmH<sub>2</sub>O ( At 50 L/min )  
Operation Temperature: -45°C~ 60°C Size: Adult, Child



**GT117-200**

**Filter-CPR-face-shield**

1000pcs/ctn, 36 X 33 X 25cm;  
1pc/bag, 1000bags/ctn, 36 X 36 X 23cm



**GT117-400**

**Nasal Specula**

Made from non-toxic ABS  
Used for inspecting the nasal cavity  
Packed in individual PE Bag  
200pcs/ctn, Dimension: 49.5X37X34cm



# Endotracheal Tube

Available with cuff (high volume low pressure) and without cuff.  
X-ray opaque line throughout the length of the tube,  
With 15mm standard connector.



## GT014-100 Oral / Nasal Endotracheal Tubes

Made from non-toxic PVC, transparent soft and smooth / With cuff  
High volume cuff provides positive tracheal wall seal  
Designed for use during short and long term ventilation  
and routine surgical procedures  
Available with Murphy eye only Packed in individual Blister bag  
Size:3.0mm-4.5mm, 100pcs/ctn, Dimension:42X29X23cm  
Size:5.0mm-10.0mm, 100pcs/ctn, Dimension:49.5X37X34cm

## GT014-200 Oral / Nasal Endotracheal Tubes

Made from non-toxic PVC, transparent soft and smooth  
Without cuff  
Radio opaque line through the length for X-ray visualization  
Packed in individual Blister bag  
Size:2.0mm-4.5mm, 100pcs/ctn,  
Dimension:42X29X23cm  
Size:5.0mm-10.0mm, 100pcs/ctn,  
Dimension:49.5X37X34cm

Medical Tubes



## GT014-300 Nasal Preformed Tracheal Tubes

Special PVC blend for enhanced softness and soft atraumatic tip,  
nasal surgical intubation only  
With cuff  
Provides positive tracheal wall seal and reduces area of tracheal  
wall contact and minimizes capillary restriction  
Packed in individual Blister bag  
Size:4.0mm-4.5mm, 100pcs/ctn, Dimension: 42X29X23cm  
Size:5.0mm-10.0mm, 100pcs/ctn, Dimension: 49.5X37X34cm

## GT014-400 Nasal Preformed Tracheal Tubes

Made from non-toxic PVC, transparent soft and smooth  
Without cuff  
X-ray through the whole tube  
Nasal surgical intubation only  
Packed in individual Blister bag  
Size:3.0mm-4.5mm, 100pcs/ctn, Dimension:42X29X23cm  
Size:5.0mm-10.0mm, 100pcs/ctn, Dimension:49.5X37X34cm



## GT014-500 Oral Preformed Tracheal Tubes

Made from non-toxic PVC, transparent soft and smooth / With cuff  
X-ray through the whole tube, tubes available with Murphy eye  
Packed in individual Blister bag  
Size:3.0mm-4.5mm, 100pcs/ctn, Dimension:42X29X23cm  
Size:5.0mm-10.0mm, 100pcs/ctn, Dimension:49.5X37X34cm

## GT014-600 Oral Preformed Tracheal Tubes

Made from non-toxic PVC, transparent soft and smooth  
Without cuff  
X-ray through the whole tube  
Packed in individual Blister bag  
Size:3.0mm-4.5mm, 100pcs/ctn, Dimension:42X29X23  
Size:5.0mm-10.0mm, 100pcs/ctn, Dimension:49.5X37X34

GT015-100

GT015-200

**Tracheostomy tube**

Made from non-toxic PVC  
 Be used in Tracheostomy  
**90° CURVATURE**  
 With 15mm standard connector  
 X-ray opaque line throughout the length of the tube  
 Available with of standard low pressure cuff and without cuff  
 Pre-connected neck-tape

**GT015-100 Tracheostomy Tube**

With cuff  
 Size: 5.0mm-10.0mm  
 Packed in individual Hard Blister Bag  
 100pcs/ctn, Dimension: 45X39.5X32cm

**GT015-200 Tracheostomy Tube**

Without cuff  
 Size: 3.mm-10.0mm  
 Packed in individual Hard Blister Bag  
 100pcs/ctn, Dimension: 45X39.5X32cm

**GT016-100 Guedel Airways**

Made from semirigid non-toxic polyethylene.  
 Color-coded bite back  
 Guedel style enclosed center channel  
 Packed in individual PE Bag

Size available:

000#, 40mm, pink	1000pcs/ctn, Dimension: 52X38X52cm
00 #, 50mm, blue	1000pcs/ctn, Dimension: 52X38X52cm
0 #, 60mm, black	500pcs/ctn, Dimension: 52X38X52cm
1 #, 70mm white	500pcs/ctn, Dimension: 52X38X52cm
2 #, 80mm, green	500pcs/ctn, Dimension: 52X38X52cm
3 #, 90mm, yellow	500pcs/ctn, Dimension: 52X38X52cm
4 #, 100mm, red	500pcs/ctn, Dimension: 52X38X52cm
6 #, 120mm, orange	500pcs/ctn, Dimension: 52X38X52cm



**GT014-700 Reinforced Endotracheal Tubes ( Oral / Nasal)(With / Without Cuff)**

Made from non-toxic PVC  
 It provides positive tracheal wall seal  
 Suitable for any patient positions,  
 especially for OPS of decubitus  
 Packed in individual Blister bag  
 Size: 4.0mm - 10.0mm, 200pcs/ctn,  
 Dimension: 50X34X42.5 cm

**GT014-800D Central Venous Catheter**

Delicate smooth pipe tip is made of excellent custom-built special material of polyurethane. Made by welding forming, the super-smooth treatment and treatment of showing the site of pipe makes embedding of pipe into blood vessels easier and safer.

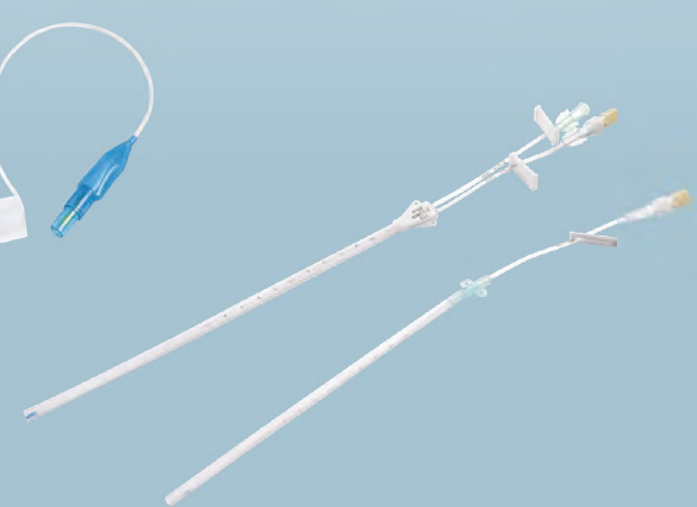



### GT017-100 Suction Catheter

Made from non-toxic, non-irritant soft PVC  
 Distal end is opened with two lateral eyes  
 Four kinds of connector available: T-type connector,  
 Y-type connector, Cap-cone connector, Plain type connector,  
 Color coded for size identification  
 With X-ray or without is available  
 Standard Tube Length : 50 cm  
 Size: Fr5-Fr24  
 Packed in individual PE Bag 1000pcs/ctn,  
 Dimension: 57X37X45cm



### GT017-200 Extractor Mucus

Suitable for obtaining mucus specimen for microbiological examination  
 Also suitable for aspiration of secretion from Oropharynx  
 of new born babies to ensure free respiration  
 Soft, frosted and kink resistant PVC tubing  
 Atraumatic, soft and rounded, open tip with two lateral eyes  
 Clear transparent container permits visual examination of aspirate  
 Spare screw top lid is provided to seal the container for safe  
 transportation of specimen to the laboratory or aseptic  
 disposal of container  
 Suction tube lengths available : 40 cms, 50 cms  
 Capacity : 25 ml  
 Size: Fr6-Fr14  
 Packed in individual Blister Bag 100pcs/ctn,  
 Dimension: 60X32X25cm



### GT018-100 Feeding Tube

Made from non-toxic, non-irritant soft PVC.  
 Color coded for size identification  
 With X-ray or without is available.  
 Packed in individual PE Bag  
 Size: Fr4- Fr8 Tube Length: 40cm  
 1000pcs/ctn Dimension: 44X22X45cm  
 Size:Fr10-Fr22 Tube Length: 120 cm  
 500pcs/ctn, Dimension: 57X37X44cm



### GT019-100 Stomach Tube

Made from non-toxic, non-irritant soft PVC  
 or made from 100% silicone  
 Printed with graduation .  
 Color coded for size identification  
 With X-ray or without is available.  
 Packed in individual PE Bag  
 Standard Tube Length : 120 cm  
 Size: Fr6- Fr16 500pcs/ctn Dimension: 53.5X37X43cm  
 Size: Fr18- Fr24 400pcs/ctn Dimension: 57X37X45cm



### GT019-200 Disposable silicone Thoracic Catheter

1. Most suitable for post-operative drainage after cardio-thoracic and thoracic surgery
2. Atraumatic and rounded open distal end with smooth eyes
3. Sterile, non-toxic & pyrogen-free
4. Thoracic tube made of medical silicone
5. With radiopaque line
6. Round or fish-mouth tip
7. Size: Fr16-Fr38



**GT020-100 Rectal tube**

Made from non-toxic, non-irritant soft PVC  
 Color coded for size identification  
 With X-ray or without is available  
 Standard tube length: 40cm  
 Size: Fr24-Fr28  
 Packed in individual PE Bag 400pcs/ctn,  
 Dimension: 50X29X37cm



**GT021-100 Nelaton Catheter (PVC)**

Made from non-toxic, non-irritant soft PVC  
 Color coded for size identification  
 With X-ray or without is available  
 Standard tube length: 40cm  
 Size: Fr6-Fr24  
 Packed in individual PE Bag 1000pcs/ctn,  
 Dimension: 47X37X42cm

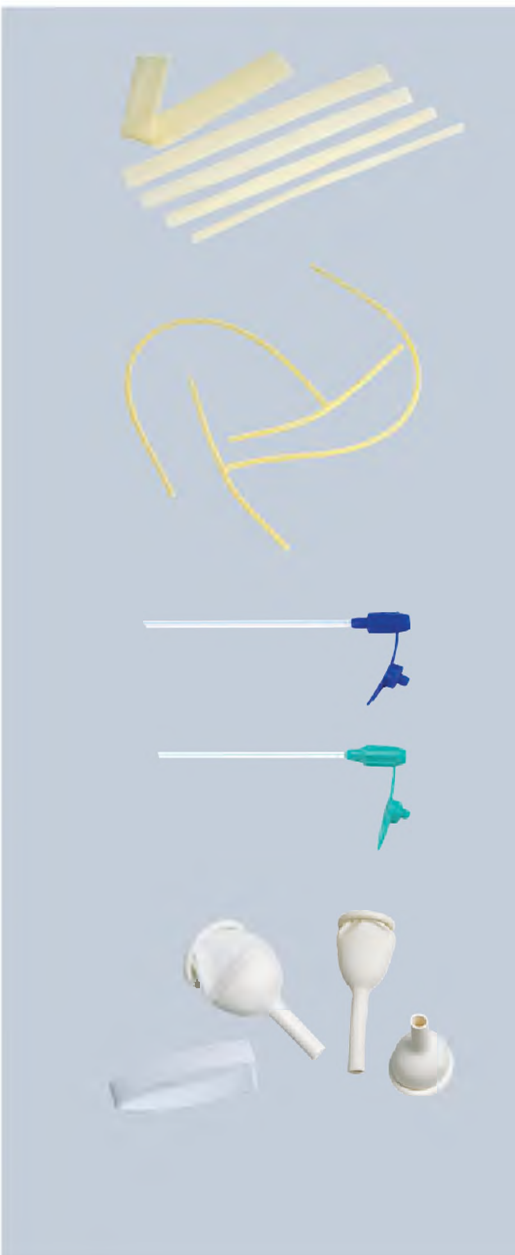

**GT024-100 Penrose Drainage Tube**

Made from natural latex  
 Size: 1/4", 5/16", 3/8", 1/2", 5/8", 3/4", 7/8", 1"  
 Length: 450mm  
 Packed in individual Blister Bag  
 500pcs/box, 5000pcs/ctn, Dimension: 50X25X29cm

**GT025-100 T-Drainage Tube**

Made from natural latex, Silicone coated  
 Used for the drainage of the operation of Cholecyst  
 The connector part is larger in diameter than other parts  
 Size: Fr10-Fr26  
 Packed in individual Blister Bag  
 200pcs/ctn, Dimension: 49.5X37X34cm

**GT025-200 Umbilical catheter**

Made from soft PVC.  
 Designed for intermittent continuance access to the umbilical artery or vein of newly born or premature infant.  
 Individually straight packed in paper pouch packing to ensure aseptic handling.  
 Size: FG-5 (Gray), FG-6 (Green) & FG-8 (Blue)  
 Length: 125cm  
 Tube is marked at 5, 6, 7, 8, 9, 10, 15cms

**GT026-100 Condom Catheter**

Made from natural latex  
 Size: 25mm, 30mm, 35mm and 40mm  
 Packed in individual Blister Bag  
 100pcs/box, 1000pcs/ctn, Dimension: 56X54X28cm



# Foley Catheter

Made from natural latex

Silicone coated

Available with the option of plastic valve or rubber valve

Colour-coded for visualisation of size



## GT022-200 2-way Latex Foley Catheter

Made from natural latex

Silicone coated

Plastic valve or Rubber valve is available

Color-coated for visualization of size

Fr6-Fr10 (Pediatric)

Length:270mm Balloon Capacity:3cc/5cc

Fr12-Fr22 (Standard)

Length:400mm Balloon Capacity:5cc/10cc/30cc

Fr24-Fr26 (Standard)

Length:400mm Balloon Capacity:10cc/30cc

Packed in individual Blister bag

10pcs/box, 500pcs/ctn, Dimension:52X43X47.5 cm

Medical Tubes



## GT022-300

### 3-Way Latex Foley Catheter

Made from natural latex

Silicone coated

Plastic valve or Rubber valve is available

Color-coated for visualization of size

Fr16-Fr26 (Standard)

Length:400mm Balloon Capacity:30cc

Packed in individual Blister bag

10pcs/box, 500pcs/ctn,

Dimension:52X43X47.5 cm

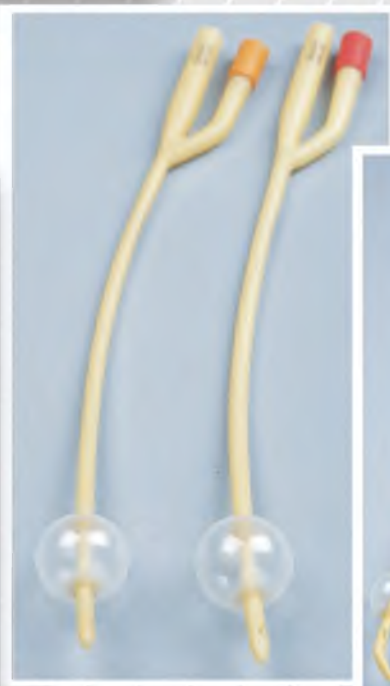

## GT022-400

### 2-Way Female Foley Catheter

Made from natural latex

Silicone coated

Plastic valve or Rubber valve is available

Color-coated for visualization of size

Fr12-Fr22

Length:240mm , Balloon Capacity:5cc/10cc/30cc

Fr24-Fr26

Length:240mm, Balloon Capacity:10cc/30cc

Packed in individual Blister bag

10pcs/box, 500pcs/ctn,

Dimension:52X43X47.5cm



## GT022-500

### 2-Way Tiemann Foley Catheter

Made from natural latex

Silicone coated

Plastic valve or Rubber valve is available

Color-coated for visualization of size

Fr12-Fr22

Length:400mm Balloon Capacity:5cc/10cc/30cc

Fr24

Length:400mm Balloon Capacity:10cc/30cc

Packed in individual Blister bag

10pcs/box, 500pcs/ctn,

Dimension:52X43X47.5cm



**GT022-600  
3-Way Double Balloons  
Foley Catheter**

Made from natural latex  
Silicone coated  
Color-coated for visualization of size  
Fr16-Fr24  
Length:400mm  
Balloon Capacity:30cc(front) / 50cc(rear)  
Packed in individual Blister bag  
10pcs/box, 500pcs/ctn,  
Dimension:52X43X47.5cm



**GT022-700  
4-Way Double Balloons Foley Catheter**

Made from natural latex  
Silicone coated  
Color-coated for visualization of size

**Type A:**

Fr16-Fr24  
Length:400mm Balloon Capacity: 30cc(front) / 50cc(rear)

**Type B:**

Fr16-Fr24  
Length:400mm Balloon Capacity: 50cc(front) / 30cc(rear)  
Packed in individual Blister bag  
10pcs/box, 500pcs/ctn, Dimension:52X43X47.5cm

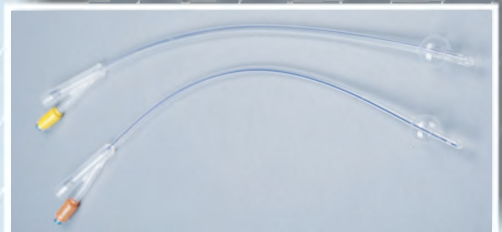

**GT022-900  
2-Way All Silicone Catheter**

Made from high quality 100% silicone, medical grade  
With X-ray or without is available  
Fr8-Fr10 (Pediatric)  
Length:310mm Balloon Capacity:3cc/5cc  
Fr12-Fr14 (Standard)  
Length:400mm Balloon Capacity:5cc/10cc  
Fr16-Fr24 (Standard)  
Length:400mm Balloon Capacity:5cc/10cc/30cc  
Packed in individual Blister bag  
10pcs/box, 500pcs/ctn, Dimension:52X43X47.5cm



**GT022-100  
Urethral Catheter (Red Latex)**

Made from natural latex  
Silicone coated  
Fr6-Fr24  
Length:400mm  
Packed in individual Blister bag  
10pcs/box, 500pcs/ctn,  
Dimension:52X43X47.5cm



**GT023-100  
Malecot Catheter**

Made from natural latex  
Silicone coated  
Fr14-Fr36  
Length:400mm  
Packed in individual Blister bag  
10pcs/box, 500pcs/ctn,  
Dimension:52X43X47.5cm



**GT023-200  
Closed suction catheter**

Closed suction catheter set consists of a three-way valve, a control box assembly and a suction catheter.

The suction catheter extends from the three-way valve to the control box and is covered in thin film. The three-way valve has distilled water delivery port for cleaning after use.

When in use, the three-way valve connects to an endotracheal tube through patient port and a ventilator through the breathing port.

Control box button activates suctioning and suction catheter can be inserted or retracted through the three-way valve into patients airway.

The catheter is graduated for easy identification of depth of insertion.

1. Grip three-way Adaptor with one hand. Insert catheter down into Endotracheal tube with thumb and forefinger of another hand, and 10 seconds is preferred for each suction operation.
2. After insert catheter to the desired depth, depress the control valve simultaneously to apply suction.
3. After suction withdraw the catheter gently until the protective sleeve is straight.
4. Depress the control valve to flush the catheter by saline solution/distilled water through irrigation port for the next use.



# URINE BAG

2000-ml  
With Anti - Reflux Valve.  
Sterile Fluid Pathway



WASH HANDS BEFORE AND  
AFTER ALL PROCEDURES

150 ml —  
100 ml —  
50 ml —  
25 ml —

APPROXIMATE ML  
2000 ml  
1800 ml  
1600 ml  
1400 ml  
1200 ml  
1000 ml  
800 ml  
600 ml  
400 ml  
200 ml





**GT028-100**

**Economic Urinary Drainage Bag**

Capacity: 2000ml

Without bottom outlet; with 90cm inlet tube, with non-return valve,

Sterilization: EO

Packing: 1pc/PE bag, 250pcs/carton

Measurement of carton: 52x32x36cm



**GT028-200**

**Economic Urinary Drainage Bag**

Capacity: 2000ml

with bottom outlet; with 90cm inlet tube; with non-return valve

with pull-push valve

Sterilization: EO

Form of packing: 1pc/PE bag, 250pcs/carton

Measurement of carton: 540x400x270mm



**GT028-210**

**Economic Urinary Drainage Bag**

Capacity: 2000ml

With bottom outlet; with 90cm inlet tube; with non-return valve, with T valve

Sterilization: EO

Packing: 1pc/PE bag, 250pcs/carton

Measurement of carton: 52x37x32cm



**GT028-300**

**Luxury Urinary Drainage Bag**

Capacity: 2000ml

Type: square bottom, latex free, with pull push valve, with white sample port, with anti-reflux valve, with plastic tie

Inlet tube: O.D 10mm; 100cm length

Sterilization: EO

Packing: 1pc/PE or blister pack, 100pcs/carton,

Measurement of carton: 54x36x32cm





**GT028-310  
Luxury Urinary Drainage Bag**

Capacity: 2000ml  
 Type: Square bottom; Latex free  
 with twist valve; with white sample port;  
 with anti-reflux valve ; with plastic tie  
 Inlet tube: O.D 10mm; 100cm length  
 Sterilization: EO  
 Form of packing: 1pc/Blister pack, 100pcs/carton  
 Measurement of carton: 540x360x320mm



**GT028-320  
Luxury Urinary Drainage Bag**

Capacity: 2000ml  
 Type: Square bottom; Latex free  
 with T valve; with white sample port;  
 with anti-reflux valve ; without plastic tie  
 Inlet tube: O.D 10mm; 100cm length  
 Sterilization: EO  
 Form of packing: 1pc/Blister pack, 100pcs/carton  
 Measurement of carton: 540x360x320mm



**GT028-330  
Luxury Urinary Drainage Bag**

Capacity: 2000ml  
 Type: Square bottom; Latex free  
 with T valve; with white sample port; with anti-reflux valve  
 with plastic tie  
 Inlet tube: O.D 10mm; 100cm length  
 Sterilization: EO  
 Form of packing: 1pc/Blister pack, 100pcs/carton  
 Measurement of carton: 540x360x320mm



**GT028-340  
Luxury Urinary Drainage Bag**

Capacity: 2000ml  
 Type: Square bottom; Latex free  
 with T valve; without sample port; with anti-reflux valve  
 with double ropes  
 Thickness film: 0.11mm per ply, Front film is transparent  
 Back film is white  
 Inlet tube: O.D 6.5mm; 90cm length  
 Sterilization: EO  
 Form of packing: 1pc/Blister pack, 100pcs/carton  
 Measurement of carton: 540x360x320mm



**GT028-400**

**Luxury Urinary Drainage Bag**

Capacity: 2000ml

Type: Square bottom; Latex free with side valve; with anti-reflux valve with single plastic hanger and tubing clip

Inlet tube: O.D 10mm; 110cm length

Sterilization: EO

Form of packing: 1pc/Blister pack, 40pcs/carton

Measurement of carton: 430x320x380mm



**GT028-410**

**Luxury Urinary Drainage Bag**

Capacity: 2000ml

Type: Square bottom; Latex free with Single reversal valve; with needle sample port with anti-reflux valve;

with double plastic hanger and single rope with blue bed sheet clip

Inlet tube: O.D 10mm; 100cm length

Sterilization: EO

Form of packing: 1pc/Blister pack, 40pcs/carton

Measurement of carton: 430x320x380mm



**GT028-500**

**Luxury Urinary Drainage Bag**

Capacity: 2000ml

Type: Square bottom; Latex free with twist valve; with anti-reflux valve; with plastic tie

Front and back films are transparent

Inlet tube: O.D 6.5mm; 90cm length

Sterilization: EO

Form of packing: 1pc/Blister pack, 100pcs/carton

Measurement of carton: 450x360x330mm



**GT028-510**

**Luxury Urinary Drainage Bag**

Capacity: 2000ml

Type: semicircular bottom, Latex free with twist valve; with anti-reflux valve; with plastic tie

Front and back films are transparent

Inlet tube: O.D 6.5mm; 90cm length

Sterilization: EO

Form of packing: 1pc/PE bag, 100pcs/carton

Measurement of carton: 440x360x240mm



**GT028-600**

**Luxury Urinary Drainage Bag**

Capacity: 2000ml

Type: pyriform; latex free, with 100% silicone blue outlet and with folding clamp, with needle sample port, with anti-reflux valve, with finger guard clamp

Inlet tube: O.D10mm; 100cm length

Sterilization: EO

Form of packing: 1pc/PE or blister pack, 20pcs/carton.

Measurement of carton: 38x22x15cm



**GT028-700**

**Urinary Drainage Bag**

Capacity: 2000ml

Type: Pyriform; Latex free with T valve; with needle sample port; with anti-reflux valve with double plastic hanger and rope; with white bed sheet clamp

Inlet tube: O.D 10mm; 110cm length

Sterilization: EO

Form of packing: 1pc/Blister pack, 40pcs/carton

Measurement of carton: 430x300x380mm



**GT028-800**

**Urinary Drainage Bag**

Capacity: 2000ml

Type: Pyriform; Latex free with T valve; with needle sample port; with anti-reflux valve with blue plastic hanger and rope; with white bed sheet clamp

Inlet tube: O.D 10mm; 100cm length

Sterilization: EO

Form of packing: 1pc/Blister pack, 20pcs/cart



**GT028-810**

**Urinary Drainage Bag**

Capacity: 2000ml

Type: Pyriform; Latex free with T valve; with needle sample port; with anti-reflux valve with white double plastic hanger and rope; with white bed sheet clamp

Inlet tube: O.D 10mm; 110cm length

Sterilization: EO

Form of packing: 1pc/Blister pack, 40pcs/carton

Measurement of carton: 430x300x380mm



**GT028-900**  
**Luxury Urinary Drainage Bag**  
 Capacity: 4000ml  
 with T valve; Latex free;  
 with anti-reflux drip chamber (one part)  
 with needle sample port and tubing clip is optional  
 with anti-reflux valve;  
 with reinforced double plastic hanger and rope  
 with blue bed sheet clamp  
 Inlet tube: O.D 11mm; 110cm length  
 Sterilization: EO  
 Form of packing: 1pc/Blister pack, 40pcs/carton  
 Measurement of carton: 430x300x380mm



**GT028-910**  
**Luxury Urinary Drainage Bag**  
 Capacity: Type A : 2000ml / Type B : 2500ml  
 with T valve; Latex free;  
 with anti-reflux drip chamber (one part)  
 with needle Sample port and tubing clip is optional  
 with anti-reflux valve;  
 with reinforced double plastic hanger and rope  
 with white bed sheet clamp  
 Inlet tube: O.D 10mm; 110cm length  
 Sterilization: EO  
 Form of packing: 1pc/Blister pack, 40pcs/carton  
 Measurement of carton: 430x300x380mm



**GT028-920**  
**Luxury Urinary Drainage Bag**  
 Capacity: 2000ml  
 with T valve; Latex free;  
 with anti-reflux drip chamber (Three part)  
 with needle sample port and tubing clip is optional  
 with anti-reflux valve;  
 with reinforced double plastic hanger and rope  
 with blue bed sheet clamp  
 Inlet tube: O.D 11mm; 110cm length  
 Sterilization: EO  
 Form of packing: 1pc/Blister pack, 40pcs/carton  
 Measurement of carton: 430x300x380mm



**GT029-100**  
**Luxury Urinary Drainage Bag**  
 Capacity: 2000ml  
 with T valve; Latex free;  
 with anti-reflux drip chamber (Three part)  
 with needle sample port and tubing clip is optional  
 with anti-reflux valve;  
 with reinforced double plastic hanger and rope  
 with blue bed sheet clamp  
 Inlet tube: O.D 11mm; 110cm length  
 Sterilization: EO  
 Form of packing: 1pc/Blister pack, 40pcs/carton  
 Measurement of carton: 430x300x380mm



**GT029-300**

**Urine Meter Drainage Bag**

Capacity: 2600ml +400ml; Latex free  
 with T valve on urine bag;  
 with twist valve on urine meter  
 with needle sample port; with anti-reflux valve  
 with reinforced double plastic hanger and rope  
 with white bed sheet clamp  
 Inlet tube: O.D 11 mm; 130cm length  
 Sterilization: EO  
 Form of packing: 1pc/Blister pack, 10pcs/carton  
 Measurement of carton: 480x410x250mm



**GT029-310**

**Urine Meter Drainage Bag**

Capacity: 2600ml +500ml, Latex free  
 with T valve on urine bag ; with twist valve on urine meter  
 with needle Sample port; with anti-reflux valve  
 with reinforced double plastic hanger and rope  
 with white bed sheet clamp  
 Inlet tube: O.D 11mm; 130cm length  
 Sterilization: EO  
 Form of packing: 1pc/Blister pack, 10pcs/carton  
 Measurement of carton: 480x410x250mm

Urine Bag



**GT029-320**

**Urine Meter Drainage Bag**

Capacity: 2000ml +200ml; Latex free  
 with T valve on urine bag; with twist valve on urine meter  
 with needle sample port; with anti-reflux valve  
 with reinforced double plastic hanger and rope  
 with white bed sheet clamp  
 Inlet tube: O.D 11 mm; 130cm length  
 Sterilization: EO  
 Form of packing: 1pc/Blister pack, 10pcs/carton  
 Measurement of carton: 480x410x250mm



**GT029-330**

**Urine Meter Drainage Bag (Double Chambers)**

Easy to read molded plastic meters are calibrated up to  
 400 ml urine meter  
 with T valve on urine bag ; with twist valve on urine meter  
 with needle sample port; with anti-reflux valve  
 with reinforced double plastic hanger and rope  
 with white bed sheet clamp  
 Inlet tube: O.D 11 mm; 130cm length  
 Sterilization: EO  
 Form of packing: 1pc/Blister pack, 10pcs/carton  
 Measurement of carton: 480x410x250mm



**GT029-340**

**Urine Meter Drainage Bag**

Easy to read molded plastic meters are calibrated up to 500 ml urine meter  
 with 2000ml Luxury Urinary Drainage bag  
 with anti-reflux drip chamber (one part)  
 with T valve on urine bag; with needle sample port with anti-reflux valve;  
 with four belts & two belts to be choose  
 Inlet tube: O.D 11 mm; 130cm length  
 Sterilization: EO  
 Form of packing: 1pc/Blister pack, 10pcs/carton  
 Measurement of carton: 580x290x235mm



**GT029-400**

**Leg Bag**

Capacity: 600ml  
 Type: Square  
 with blue pull-push valve & blue tip cover  
 with anti reflux valve; with double high elastic belts  
 Sterilization: EO  
 Form of packing: 1pc/PE bag, 48pcs/carton  
 Measurement of carton:  
 300x260x150mm With 120cm tube



**GT029-410**

**Leg Bag**

Capacity: 500ml & 1000ml  
 Type: ellipse shape  
 with green twist valve & green tip cover  
 with anti reflux valve; with double high elastic belts  
 Sterilization: EO  
 Form of packing: 1pc/PE bag, 48pcs/carton  
 Measurement of carton: 300x260x150mm



**GT029-420**

**Leg Bag**

Capacity: 500 ml  
 Type: ellipse shape  
 with T valve & short outlet tube;  
 with anti reflux valve  
 Sterilization: EO  
 Form of packing: 1pc/Blister pack, 100pcs/carton  
 Measurement of carton: 550x400x325mm



**GT029-430**

**Leg Bag**

Capacity: 500 ml

Type: ellipse shape

with T valve & short outlet tube;

with double high elastic belts

Sterilization: EO

Form of packing: 1pc/Blister pack, 100pcs/carton

Measurement of carton: 380x260x230mm



**GT029-500**

**Disposable Pediatric Urine Collector**

Size: 100ml, 200ml

Component: pectic paper, PVC bag, sponge

Sterilization: EO

Form of packing: 1pc/PE pack, 5000pcs/carton

Measurement of carton: 550x540x430mm



**GT029-610**



**GT029-620**

**GT029-610 / GT029-620**

**Wound Drainage System**

Parts: Container, two to the connector, drainage pipe, connecting pipe, needle, non-return valve, and so on.

Main raw materials: PVC and/or silicone rubber According to drainage pipes and containers of different materials used can be divided into PP, PS, SS three types According to the capacity of different containers can be divided into 200ml, 400ml, 500ml and 800ml.

This product is used for abdominal, chest, breast and other parts of the fluid, pus and blood drainage.

200ml 20PCS/43x32x19cm

400ml 12PCS/43x32x19cm

500ml 24PCS/55x32x48cm

800ml 12PCS/45x32x48cm



**GT029-800**

**Disposable Colostomy Bag**

Size: 20cm x 14cm, 25cm x 15cm  
 Adhesive area: 10cm x 9cm, 12cm x 12cm  
 Center opening:  $\varnothing$ 3cm  
 Sterilization: EO  
 Form of packing:  
 20pc/PE bag, 5 bags/box, 20boxes/carton  
 Measurement of carton:  
 470x330x240mm(20cm x 14cm)  
 580x350x240mm(25cm x 15cm)



**GT029-900V**

**Disposable Enema Bag**

Capacity: 1500ml  
 Material: PVC  
 Sterilization: EO  
 Form of packing:  
 1pc/PE bag, 200pcs/carton  
 Measurement of carton:  
 460x440x330mm



**GT031-100**

**Disposable Enteral Feeding Bag Set**

Size: 500ml, 1000ml, 1200ml  
 Available for Pump Using and Gravity Using  
 Packed in individual PE Bag  
 30pcs/ctn,  
 Dimension: 40X28X25cm



**GT031-500**

**Irrigation syringe**

Flat: 80ml, 60ml  
 Parts: Protector cap(PE), barrel(PP), piston(synthetic rubber), handspike(PP), two way(PP) 400pcs/58x44x46cm Ring: 60ml  
 Parts: Protector cap(PE), barrel(PP), piston(synthetic rubber), handspike(PP), two way(PP) 250pcs/58x44x46cm  
 Bulb: 50ml, 60ml Parts: Protector cap(PE), barrel(PP), bulb(PE), two way(PP) 50pcs/35x26x34cm



CE Approved

# Hypodermic & Surgical Instruments





# Disposable Infusion Set

Plastic drip chamber  
Vented spike with cap  
PVC tube

Flow regulator  
Injection part  
With Hypodermic needle  
or without is available

**Material:**PVC

**Parts:**Plastic needle+small chamber  
+filter+flow regulator+rubber gum bubble  
+two way+needle 500PCS/58x38x38cm

**Parts:**Plastic needle+small chamber+filter  
+flow regulator+Y site+two way  
+needle 400PCS/64x34x38cm

**GT034-100**

**Disposable infusion set**

Small Chamber  
With Latex Tube  
With Filter

**GT034-101**

**Disposable infusion set**

Small chamber  
with Y site  
with filter  
with luer lock adapter

**GT035-102**

**Disposable infusion set**

Big chamber  
With Y site  
With filter  
Luer lock adapter with protector

**GT034-200**

**Burette Infusion Set**

with Burette: 100ml, 150ml  
with Y site  
with filter  
luer lock adapter with protector



**GT035-100  
Disposable Blood Transfusion Set**

Designed for transfusion of blood or blood component  
 Moulded latex flush ball injection membrane for I  
 ntermittent medication  
 Approximately 20 drops / ml  
 Clear, transparent and soft tubing manufactured  
 from medical grade PVC  
 With 200 micron filter and 18 G hypodermic needle  
 Options available  
 With or without Airvent  
 With or without Needle  
 With or without "Y" site (Latex or Latex – free)  
 Luer lock or luer slip  
 Packing: PE package or paper-plastic package

Hypodermic &  
Surgical Instruments



**GT039-100  
Stopcock Three way**

Parts: Body(PC), Plug(PE); Screw cap(ABS)  
 Cold and heat tests, and the products will  
 not have the phenomenon of crack  
 Test pressure: 5.5kg.  
 Products Thread: 6:100 screw thread standard,  
 this in line with international GB standards.  
 1000pcs/58x38x38cm

**GT039-200  
Heparin cap**

Material: PC  
 5000pcs/51x50x32cm



**GT038-200  
Dental needle**

Size: 25GX25mm, 25GX32mm, 25GX38mm,  
 27G X 25mm; 27GX32mm, 27G X 38mm,  
 30G X25mm, 30GX32mm, 30GX38mm  
 Parts: Stainless steel casing, AISI Standard 304,  
 Medical grade PVC, within the spiral.  
 Automatic out-needle device,  
 top surface: Opaque non-slip PE,  
 bottom surface: transparent PE.  
 Packing: 1pc/plastic bag, glue paper indicate size,  
 50pcs/box, 100boxes/carton(44x30x33cm)



**GT037-400  
Safety Auto Destruct Syringe**

Material: PVC  
 Parts: Barrel+Piston+Plunger  
 +Clip+Needle(or without needle)  
 Luer Lock or Luer Slip  
 2ml 3000PCS/59 x44x45cm  
 3ml 3000PCS/59 x44x45cm  
 5ml 2400PCS/56x44x46.5cm  
 10ml 1200PCS/56x44x46.5cm



**GT037-200  
Tubercle bacillus Syringe**



**GT037-100  
Disposable Syringe**

Material: PVC  
 Parts: Barrel+Piston+Plunger +Needle(or without needle)  
 Parts: Barrel+Plunger +Needle(or without needle)  
 Luer Lock or Luer Slip / 2 parts or 3 parts  
 1ml 3000PCS/59x44x45cm / 3ml 3000PCS/59 x44x45cm  
 5ml 2400PCS/56x44x46.5cm / 10ml 1200PCS/56x44x46.5cm  
 20ml 800PCS/59x44x44cm / 60ml 400PCS/59x44x44cm



**GT037-300  
Insulin Syringe**  
size: 100u



**GT038-100  
Disposable Needle**



**GT038-300  
Spinal needle**  
 Spinal needle  
 Needle material: stainless steel  
 Needle hub: transparent PP  
 Size: #4 1/2 - #12(26G - 18G) L50 - 150 mm  
 Length: 40mm-150mm  
 Color coded hub for size identification  
 Packed in individual Blister Bag  
 1000pcs/ctn, Dimension: 42X27X52 cm



**GT038-400  
Epidural needle**  
 #12 - #18(18G - 15G) L65 - 150 mm  
 Needle material: stainless steel  
 Needle hub: transparent PP  
 Color coded hub for size identification  
 Packed in individual Blister Bag  
 1000pcs/ctn, Dimension: 42X27X52cm

**GT038-410  
Epidural Catheter**

**GT038-420  
Connect Adapter Luer Lock**

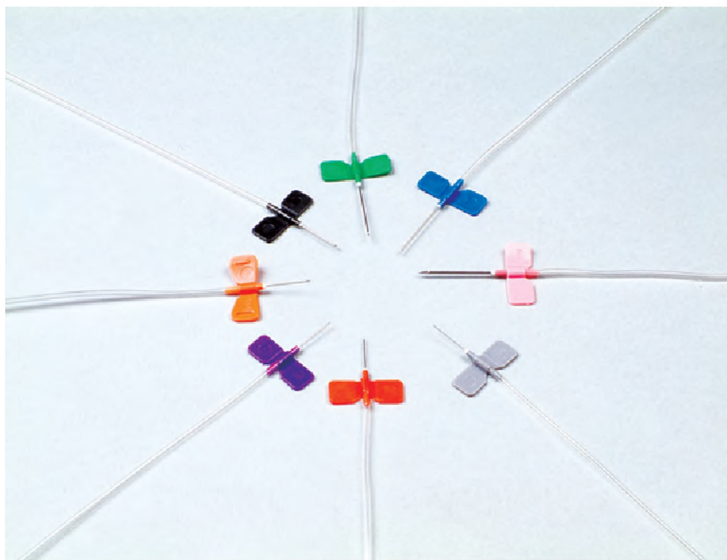

**GT038-500  
Scalp vein set**

butterfly shaped wings for better handling and attachment to skin  
 siliconed cannula for smooth penetration  
 siliconed cannula for smooth penetration  
 tube length: 15-30cm  
 gauge 18g - 26g available  
 Color coded hub for size identification  
 Sterile by eto:  
 1pc/1 poly bag 100pcs/1 box, 2000pcs/carton  
 Cartonsize: 56x25.5x37.5cm

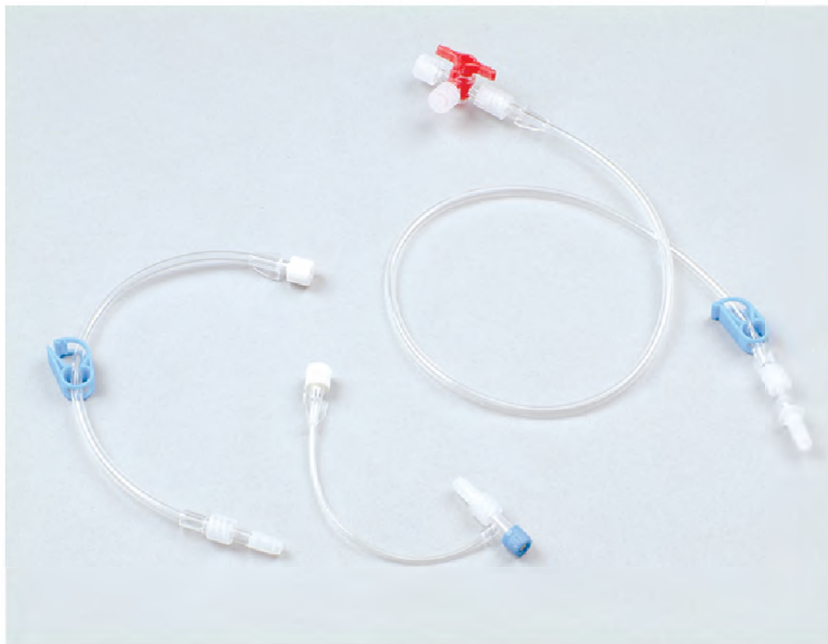

**GT033-100  
Disposable Extension set**

**Three way-Stopcock with Extension Tube**  
 Integrated Link Three ways stopcock facilitates the simultaneous administration of additional fluid from side port.  
 Fitted with male luer lock at one end for safe and secure connection and the three way stop cock at the other end.  
 Single Use, Sterile and non-Pyrogenic.  
 Packed in individual Blister Bag  
 Tube Length:  
 10-25cm 50pcs/ctn, Dimension: 72X56X32 cm  
 30-50cm 50pcs/ctn, Dimension: 72X56X32 cm  
 80cm 50pcs/ctn, Dimension: 72X56X32 cm  
 100-120cm 40pcs/ctn, Dimension: 72x56X32 cm



**GT038-600  
A.V. Needle**

Mult size:: 15G, 16G, 17G, 18G  
 Needle with bevel edge with internal and external siliconisation, Ultra thin wall, stainless steel needle with/without backeye, self highly kink resistant tube  
 Color code for size identification  
 300pcs/48x44x25.5cm

**GT038-700**

**I.V. Cannula**

Needle size: 14, 16, 18, 20, 22, 24G

I.V. Cannula with Injection port and suturable wings

I.V Cannula with suturable wings

I.V Cannula with Injection port and without Wings

Option Available :

- PTFE / FEP / PU Flex Catheter
- Hydrophobic filter
- Clear or Radio Opaque Catheter

Advantage of using PU Flex Catheter :

- Kink free
- The Catheter softens once inserted in the body
- The properties of this Catheter are similar to PU (Polyurethane)

**FEATURES:**

Japanese Needle with 3-facet Needle point to reduce penetration force

Kink resistant and specially tapered Catheter for easy vein puncture with minimum trauma

Transparent flash back chamber for easy visualization of blood to confirm venipuncture

With Luer Lock plug

Colour coding for each gauge as per International standards

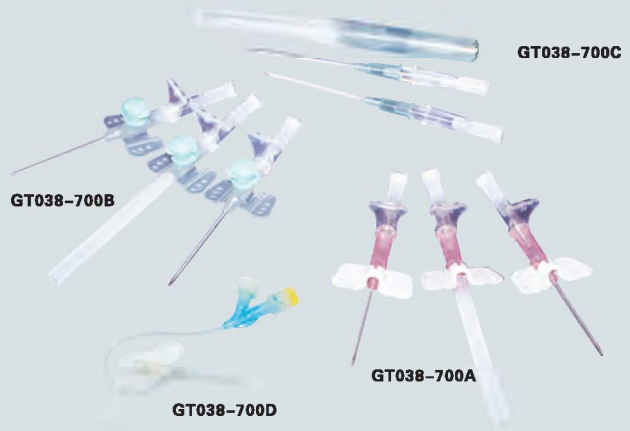

Size	Colour	Catheter (mm)		Catheter Length (mm)	Water Flow Rate (ml / min)
		I.D	O.D		
14 G	Orange	1.7	2.1	45	270
16 G	Grey	1.3	1.7	45	180
17 G	White	1.1	1.5	45	125
18 G	Green	0.9	1.3	32 / 45	80
20 G	Pink	0.8	1.1	32	54
22 G	Blue	0.6	0.9	25	33
24 G	Yellow	0.5	0.7	19	20



**GT053-100**

**Latex Powder-free Finger Cots And Powdered**

Latex Powder-free Anti-static Finger Cots.

Designed With A Proprietary Anti-static Agent That Yields Average Surface Resistance

Of 108-11 Ω Ohms Per Square Surface Unit.

It Virtually Eliminate Electro Static Discharge.

These Finger Cots Are Clean Processed And To Protect Particulates, Chemicals And Solvents With Skin.

Type: Smooth Surface With Rolled, Unrolled Or Cut Is Available.

Specification Size ±3mm

	L	M	S
Length(mm)	65	65	65
Width(mm)	29	27	25
Thickness(mm)	0.13	0.13	0.13

Packing: 100Pcs/bag, 30000Pcs/ ctn, 45 X 45 X 30cm



**GT054-200 Tourniquet**

Length: 45cmx Width:2.5cm, Stretch Length: 80-90cm

With ABS Button,

Material Of Belt, Terylene+elastic Latex

Color: Blue, Red, Green, Black,white,yellow, Purple,pink etc.

Packing: 1pc/PP bag, 50Pcs / box, 600Pcs /ctn, 57 X 38 X 37cm



**GT055-100 Latex Tube**

I. D. : 3mm-10mm

O. D. : 5mm-15mm



**GT054-100 Stanch Colligation Band**

**1. Stanch Colligation Band ( natural Latex )**

Size :width 3/4 Inch Length : 18 Inch X Thickness:0.45cm

Size :width 3/4 Inch Length : 29 Inch X Thickness:0.45cm

Size :width 1 Inch Length : 18 Inch X Thickness:0.45cm

**2. Stanch Colligation Band , Latex-free(isoprene)**

Size :width 3/4 Inch Length : 18 Inch X Thickness:0.55cm

Size :width 3/4 Inch Length : 29 Inch X Thickness:0.55cm

Size :width 1 Inch Length : 18 Inch X Thickness:0.55cm



### GT048-100 Surgical Gloves

Description :sterilized Surgical Gloves  
(Sterile By Gamma Ray).  
Powdered or powder-free  
(material): made Of Natural Latex.  
Found As Follows:  
Products Technical Datas:  
Quality:



#### Specification (mm):

Size:	6	6.5	7	7.5	8	8.5	9
Length (min,mm):	260	260	270	270	270	280	280
Width (min,mm)	77 ± 5	83 ± 5	89 ± 5	95 ± 5	105 ± 6	108 ± 6	114 ± 5

(70'cx168hours)tensile Strength (n)      Before Aging      After Aging  
 ≥ 12      9  
 Packing:packed In Cartons And In Good Condition.  
 Packing: 50Pairs/box 500Pairs/ctn, 67 X 26 X 40cm 15/13 Kgs

### GT049-100 latex examination gloves

Size: Large, Medium, Small  
Description: Powdered Or Powder-free  
Material: Made Of Natural Latex  
Products Technical Datas:



#### Specification (mm):

Size:	L	M	S	± 10mm
Length (min,mm):	230			
Width (min,mm):	110	95	80	
Thickness Single (mm):	≥ 0.08			

Physical Properties (mm): 26pcs Sampled.  
 Before Aging      After Aging

(100'cx22hours)tensile Strength (mpa)	21.0	16.0
Ultimate Elongation(%)	700	500
Packing: 100pcs/box,2000pcs/53x27x32cm 18/16kgs		



### GT051-100

#### Nitrile examination gloves

Description :nitril Examination Gloves.  
Size: XI Arge Large, Medium, Small  
Description: Powdered Or Powder-free  
Products Technical Datas:  
1 ) specification (mm):

Size:	XI	L	M	S	± 10mm
Length (min,mm):	230				
Width (min,mm)	110	100	95	80	
Thickness Single (mm):	≥ 0.08				
Physical Properties (mm):	26pcs Sampled.				

	Before Aging	After Aging
(100'cx22hours)		
Tensile Strength (mpa)	14.0	13.0
Ultimate Elongation(%)	520	410
Packing: 100pcs/box, 2000pcs/carton, 53x27x36cm 18/16kgs		



### GT052-100 PE Gloves

MATERIAL: Recycled or virgin polyethylene.  
Thickness: 0.018mm, 0.02mm, 0.022mm etc.  
Size: L, M, S  
Type: HDPE or LDPE, plain or embossed  
Color: white, Blue, pink etc.  
Packing: 100pcs/box, 10000pcs/carton, 40x32x26cm 12.5/13.5kgs  
Different thickness, sizes, color and packings is available.

### GT050-100 Vinyl Gloves

Material: Vinyl  
Product Name: Vinyl Gloves  
Grade: AQL4.0

#### General Specification:

**Size :x- Large**  
Weight: 6.0g ± 0.2  
Length: 240 ± 10mm  
The Width Of The Centre Of The Palm: 11.4cm ± 0.3  
Thickness: 0.08 ± 0.01mm  
Content Of Powderful: 0.1-0.2g

**Size: Large**  
Weight: 5.5g ± 0.2  
Length: 240 ± 10mm  
The Width Of The Centre Of The Palm: 10.6cm ± 0.3  
Thickness: 0.08 ± 0.01mm  
Content Of Powderful: 0.1-0.2g

**Size: Middle**  
Weight: 5.0g ± 0.2  
Length: 240 ± 10mm  
The Width Of The Centre Of The Palm: 10.6cm ± 0.3  
Thickness: 0.08 ± 0.01mm  
Content Of Powderful: 0.1-0.2g

**Size: Small**  
Weight: 4.5g ± 0.2  
Length: 240 ± 10mm  
The Width Of The Centre Of The Palm: 10.6cm ± 0.3  
Thickness: 0.08 ± 0.01mm  
Content Of Powderful: 0.1-0.2g

We Can Make The Other Weight As Following:

Size: S: 3.0g, 3.5g, 4.0g Etc.  
M: 3.5g, 4.0g, 4.5g Etc.  
L: 4.0g, 4.5g, 5.0g Etc.

Packing: 100pcs/box, 1000Pcs/ctn, 31.5 X 24.5 X 25cm



### GT060-101 Two fingers cots

1.2gm/pc,white  
Package: 1pc/bag,100bag/inner bag, 5000/carton  
Carton size: 400x320x27mm



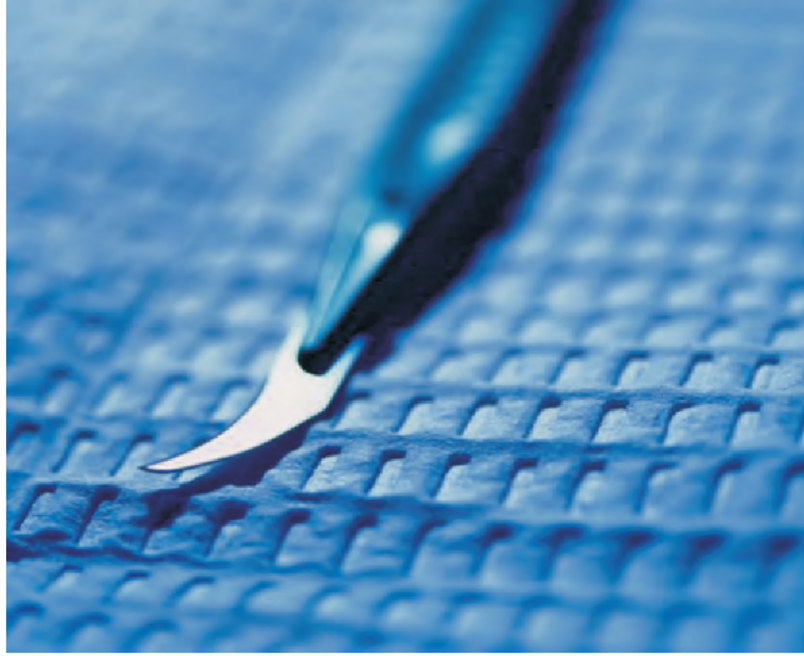

**GT040-100  
Disposable Surgical Blade**

Surgical Blades are critically made in accordance with ISO9001/ISO7740 standard. They supply very high quality to high level doctors worldwide. Our Surgical Blades have the most popular sizes to satisfy different surgery demands

Material : carbon steel or stainless steel

Size: 10#-36#

Packing: 1pc/sealed,aluminium foil bag,  
100pcs/box,5000pcs/case.

32x36x10.5cm, 9/8kgs



**GT040-300  
Disposable Skin Graft Blade**

Material: carbon steel or stainless steel

Size: 160mm

Packing: 1pc/sealed,aluminium foil bag,  
100pcs/box,1000pcs/case.  
43.5x23x18.5cm 9/8.5kgs



**GT040-200  
Disposable Stitich Cutter Blade**

Special Blades include the following sizes: stitch cutter blade 65 # and 110 # , These blades can meet your different surgical medical use requirements.

Raw material: carbon steel or stainless steel

Size: 65mm, 110mm

Packing: 1pc/sealed,aluminium foil bag, 100pcs/box,  
5000pcs/case. 65mm: 36x32x10.5cm 9/9.5kgs  
110mm: 38.5x31.5x16cm 16/15kgs.

**GT041-600  
Stainless Steel Handles**

**GT041-100  
Disposable Surgical Scalpel**

We supply many different handles for different operation requirements. Protective tab does best safety job to operators.

Disposable scalpels (Inserted model)

Packing: 10pcs/box, 500pcs/ctn, 47x37x21 cm, 6/5.5kgs

GT041-600

GT041-100





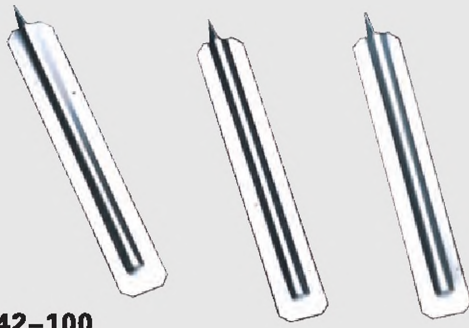

**GT042-100  
Blood Lancet**

Stainless steel Blood lancet

5pcs of packaged, 100pcs/box, 41x32.5x33cm 9/8kgs

Large 40



**GT042-200**

Plastic handle lancet, twist top

21G, 23G, 26G, 28G, 30G

**GT042-201**

Plastic handle lancet, pull top

28G, 30G

Packing: 100pcs/box, 20000pcs/ctn. 40x27x37cm 16/14kgs

200pcs/box, 20000pcs/ctn. 49x35x35cm 14/13kgs.



**GT042-202**

Softclix blood lancet

Plastic handle Flat lancet, twist top

21G, 23G, 26G, 28G, 30G

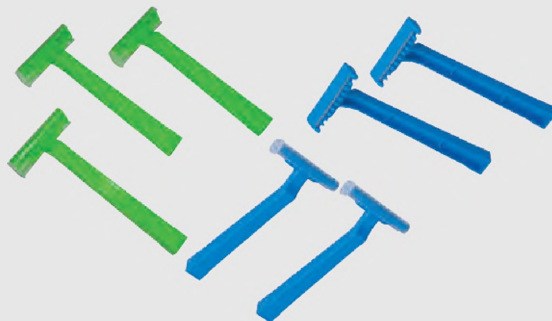

**GT043-100  
Disposable Medical Razor**

Carbon steel or stainless steel, single or double blade.

All razors come with the highest quality Stainless Steel blades or carbon steel, Comfort-Coated for smooth shaves.

Packing: 100pcs/box, 1000pcs/carton, 63x32x21cm



Hypodermic &  
Surgical Instruments



**GT042-400 / GT042-401 / GT042-402**

**Lancing device**

Lancing device with ejector,

Depth:5

Lancing Devices assist diabete patients to monitor their glucose levels, easily and safely with an adjustable dial, lancing depth can be set to an appropriate level for the individual , More safe professional system that the lancing devices with ejector for the lancets disposal.

Any standard lancet can be used with these devices.

Packing: 1pc/box, 100pcs/carton.

27.5x22x22cm 3.2/2.5kgs



**GT042-303  
Safety Lancet**

Packing: 42 X 35 X 33.5cm  
20000pcs/carton



**GT043-301  
Pressure Activated Blood Lancet**

**GT043-301Y**  
Pressure Activated Blood Lancet  
Yellow , 26G/1.8mm  
100pcs/box 50boxes(51.5x31x40cm)

**GT043-301P**  
Pressure Activated Blood Lancet  
purple,21G/2.4mm  
100pcs/box 50boxes(51.5x31x40cm)

**GT043-301G**  
Pressure Activated Blood Lancet  
Green,23G/2.4mm  
100pcs/box 50boxes(51.5x31x40cm)



**GT043-302  
Sterile Safety Lancet**

SIMPLE and SAFETY of use is what Autolance safety lancets are all about.

The complete Autolance range comprises 4 versions, with a variety of needles, blade gauge and penetration depths to meet all your capillary blood sampling requirements.

Packing: 37X21.5X14.5cm / 100pcsX10boxes

# Surgical Suture

## Features:

- 1) Suture material: polyglycolic acid (synthetic absorbable sutures), chromic and plain catgut, braided silk, monofilament nylon, monofilament polypropylene, braided polyester, and monofilament stainless steel wire
- 2) thread 45cm,60cm,75cm,100cm,125cm,150cm ect.
- 3) Thread diameter:8/0,7/0,6/0,5/0,4/0,3/0,2/0,1/0,1,2,3. ect
- 4) Needle shape: 1/2 circle, 3/8 circle, 1/4 circle, 5/8 circle, straight cutting, J-shape
- 5) Needle end type: rolled end, drilled end, regular-eye end
- 4) Needle body: taper point,blunt taper point,cuttinh edge,reverse cutting edge,tapercut,micro-point spatula curved
- 5) Sterilization method: gamma radiation or ethylene oxide (can be used directly without being re-sterilized before use)  
Inner packing: 1 set/sealed polyester and aluminum foil sachet

## Outer packing:

12 foil sachets/printed paper box or plastic container 50boxes/carton(28X28X34cm)

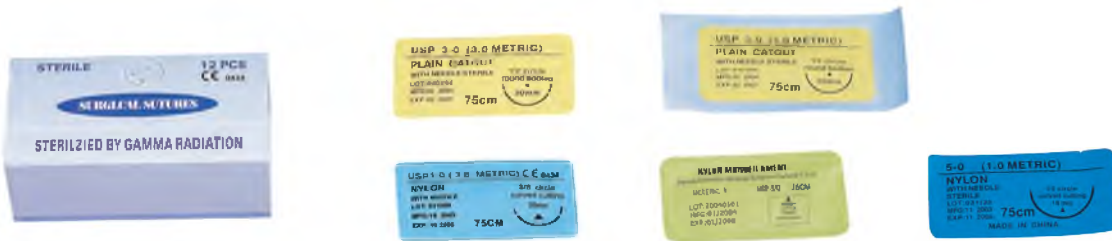

<b>Thread length:</b>	45cm, 60cm, 75cm, 100cm, 125cm, 150cm etc.
<b>Thread diameter:</b>	8/0, 7/0, 6/0, 5/0, 4/0, 3/0, 2/0, 1/0, 1, 2, 3 etc.
<b>Needle length:</b>	6mm, 8mm, 12mm, 18mm, 22mm, 30mm, 35mm,40mm, 50mm etc.
<b>Needle curvature:</b>	straight, 1/2 circle, 1/2 circle(double), 1/4 circle,1/4 circle(double), 3/8 circle, 3/8 circle(double), 5/8 circle, loop round
<b>Cross section:</b>	round bodied,roundbodied(heavy),curved cutting, curvedcutting(heavy), reverse cutting,reverse cutt-ing(heavy), tapercut,micro-point spatula curved etc.



**GT044-100**  
Chromic catgut



**GT044-200**  
Plain catgut



**GT044-700**  
Polyglycolic Acid



**GT044-300**  
Silk braided



**GT044-400**  
Nylon monofilament









**GT044-500**  
Polyester braided



**GT044-600**

# NEEDLE SHAPES

	POINT TYPE	SYMBOL
	taper point	●
	blunt taper point	●
	cutting edge	▲
	reverse cutting edge	▼
	tapercut	⊕
	micro-point spatula curved	◐

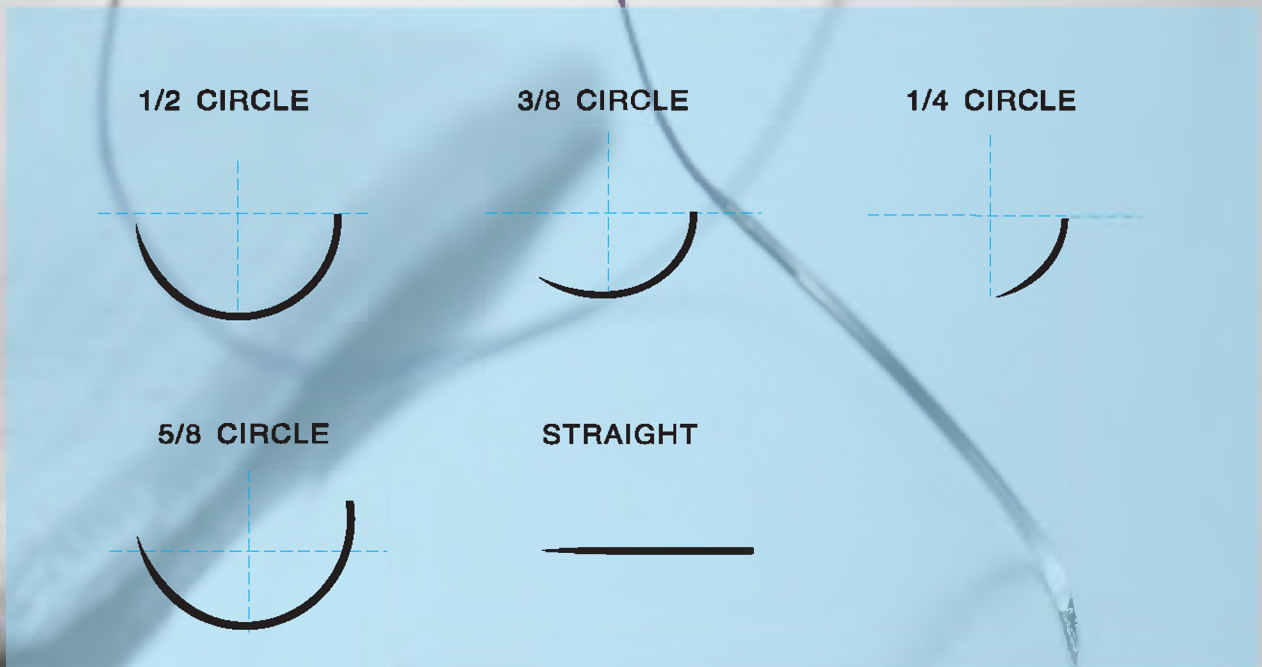



# COTTON PRODUCTS



**GT065-100 Gauze Swabs**

Material: 100% Cotton  
 Cotton Yarn: 40's X40's  
 Mesh: 18x11, 18x14, 19x9, 19x11, 19x15, 20x12, 24x20, 26x18, 28x24  
 or Other Mesh Per Customer's Demand.  
 Size: 2" x 2", 3" x 3", 4" x 4", 4" x 8" or Other Size Per Customer's Demand.  
 Ply: 4Ply, 8Ply, 12Ply, 16Ply, etc.  
 With or Without X-Ray  
 Edge: Folded or Unfolded  
 Color: White, Blue, Green  
 Sterile or Non-Sterile  
 Sterilization Method: EO or Gamma  
 Sterile Packing: 1Pc/ Two Side of Paper Pouch or One Side Paper + One Side Transparent PE Film Pouch, 2Pc/Pouch, 5Pc/Pouch or Other Packing Per Customer's Demand  
 Non-Sterile Packing: 100Pcs/ Paper Pack or 100 Pcs / Polybag;



**GT067-100 / GT067-200 Prewashed Laparotomy Sponge**

Material : 100% Cotton  
 Cotton Yarn: 40's X40's  
 Color: White Bleached, Chlorine Free, Non-Toxic, Non Abrasive, Latex Free, Clean and Dust Free  
 With X-ray Detectable or Without X-ray Detectable  
 Mesh: 18x11, 18x14, 19x9, 19x11, 19x15, 20x12, 24x20, 26x18, 28x24 or Other Mesh Per Customer's Demand  
 Size: 22.5cm X 22.5cm; 30cm X 30cm; 45cm X 45cm or Other Size Per Customer'demand;  
 Ply: 4Ply, 8Ply, 12Ply etc.  
 Sterile or Non-sterile  
 Sterilization Method: EO or Gamma  
 Sterile Packing: 5Pcs/ Two Side of Paper Pouch or One Side Paper + One Side Transparent PE Film Pouch;  
 Non-Sterile Packing: 20Pcs/Polybag or In Bulk

**GT066-100 Gauze Roll**

Material: 100% Cotton  
 Cotton Yarn: 40's X40's  
 Color: White Bleached, Chlorine Free, Non-Toxic, Non Abrasive, Latex Free, Clean And Dust Free  
 Mesh: 18x11, 18x14, 19x9, 19x11, 19x15, 20x12, 24x20, 26x18, 28x24 or Other Mesh Per Customer's Demand.  
 Size: 36" X 50m, 36" X 100yards, 36" X 100m etc.  
 Ply: 1Ply, 2Ply, 4Ply etc.  
 With or Without X-Ray  
 Packing: 1 roll/blue Kraft Paper Pack, Then Each Roll In Nylon Bag



**GT045-100 Bandage scissors**

Size: 6", 8" etc



**GT068-100 Wow Gauze Bandage**

Material: 100% Cotton  
 Cotton Yarn: 40's X40's  
 Color: White Bleached, Chlorine Free, Non-Toxic, Non Abrasive, Latex Free, Clean And Dust Free  
 Mesh: 18x11, 18x14, 19x9, 19x11, 19x15, 20x12, 24x20, 26x18, 28x24 or Other Mesh Per Customer's Demand.  
 Size: 1 1/2"/3"/4"/5"/6" x 3yds, 1 1/2"/3"/4"/5"/6" x 4yds, 1 1/2"/3"/4"/5"/6" x 5yds, 1 1/2"/3"/4"/5"/6" x 6yds , 1 1/2"/3"/4"/5"/6" x 10yds or Other Size  
 Sterile or Non-Sterile  
 Sterilization Method: EO or Gamma  
 Sterile Packing: Each Roll In Transparent Pe Airproof Pouch or Other Packing Per Customer's Demand  
 Non-Sterile Packing: 1 doz/ Blue Kraft Paper Packing



**GT070-100**  
**Non-woven swabs**

Introduction: It is made from 30% terylene and 70% glue; all cut edges are folded or unfolded and stiched evenly with a steady loop attached firmly to one corner. They are most useful for bleeding control or tissue protection in the operation rooms. It is normally with/without X-ray detectable threads or tapes and can be dyed in various colors. It meets USP and European Pharmacopoeia.

Gram of material: 30G/M2, 40G/M2... or other gram per customer's demand.  
size: 2 " x 2 " , 3 " x 3 " , 4 " x 4 " , 4 " x 8 " or other size per customer's demand.

Ply: 4ply, 8ply, 12ply, 16ply etc.

Color: White, Blue, Green

Sterile or Non-sterile

Sterilization method: EO or Gamma

Sterile Packing: 1pc/ two side of paper pouch or one side paper +one side transparent PE film pouch, 2pc/pouch, 5pc/pouch or other packing per customer's demand

Non-sterile Packing: 100pcs/ paper pack or 100 pcs / polybag;



**GT072-100**  
**Absorbent Cotton Wool**

Introduction:Made from 100% natural cotton after cleaning, purifying and bleaching, which is used for cleaning the wound. It can be made into roll.

Grade of Cotton: Natural or Super Absorbent

Weight/Roll: 50Gram, 100Gram, 125Gram, 150Gram, 200Gram, 400Gram, 454Gram, 500Gram, 1000Gram...etc.

Packing: Each roll in Blue kraft paper packing, the details dimension of carton as following

Specification	Packing	Dimension of CTN ( cm )
50g	1roll/ Blue kraft paper,500rolls/carton	58 x 52 x 51
100g	1roll/ Blue kraft paper,200rolls/carton	61 x 31.5 x 61.5
200g	1roll/ Blue kraft paper,100rolls/carton	62 x 43.5 x 40
250g	1roll/ Blue kraft paper,100rolls/carton	61 x 49 x 49
400g	1roll/ Blue kraft paper,36 rolls/carton	49 x 31 x 49
454g	1roll/ Blue kraft paper,36 rolls/carton	57 x 31 x 57
500g	1roll/ Blue kraft paper,36 rolls/carton	57 x 31 x 57
1000g	1roll/ Blue kraft paper,25 rolls/carton	63 x 31 x 63



**GT071-100**  
**Trach sponges**

Material: 100% cotton

Cotton yarn: 40'S X40'S

Mesh: ,19x11,19x15, 20x12, 24x20, or other mesh per customer's demand.

Size: 2 " x 2 " , 3 " x 3 " , 4 " x 4 "

Ply: 4ply, 8ply, 12ply, 16ply etc.

Edge: Folded or Unfolded

Color: White

Sterile or Non-sterile

Sterilization method: EO or Gamma

Sterile Packing: 1pc/ two side of paper pouch or one side paper +one side transparent PE film pouch,

2pc/pouch, 5pc/pouch or other packing per customer's demand

Non-sterile Packing: 100pcs/ paper pack or 100 pcs / polybag;



**GT073-100**  
**Zig zag cotton wool**

Introduction:Made from 100% natural cotton after cleaning, purifying and bleaching, which is used for cleaning the wound. It can be made into piece.

Grade of Cotton: Natural or Super Absorbent

Weight/bag :25Gram, 50Gram, 100Gram, 200Gram, 250Gram, 500Gram, 1000Gram, ...etc.

Packing: sealed poly bag or drawstring bag, self-sealing bag

Specification	Packing	Dimension of CTN ( cm )
25g/ bag	400bags/ctn	64 x 58 x 46
50g/bag	200 bags/ctn	63 x 46 x 46
100g/bag	100 bags/ctn	63 x 46 x 48
200g/bag	50 bags/ctn	70 x 42 x 48
250g/bag	30 bags/ctn	46 x 40 x 47
500g/bag	20 bags/ctn	68 x 50 x 43
1000g/bag	10 bags/ctn	68 x 50 x 43



**GT074-100  
Cotton Ball**

Introduction: Made from 100% natural cotton after cleaning, purifying and bleaching, which is used for cleaning the wound. It can be made into ball.

Grade of Cotton: Natural or Super Absorbent  
Weight/piece: 0.3Gram, 0.5Gram, 1.0Gram, 2.0Gram, 3.0Gram, 4.0Gram, 5.0Gram ...etc.

Packing: sealed poly bag packing.  
Sterile or Non-sterile  
Sterilization method: EO or Gamma

Specification	Packing	Dimension of CTN ( cm )
0.3G/Piece(sterile)	50piece/bag,660bags/ctn	64 x 58 x 46cm
0.3 G/Piece(sterile)	100piece/bag, 330bags/ctn	64 x 58 x 46cm
0.3G/Piece(Non-sterile)	1000piece/bag,33bags/ctn	64 x 58 x 46cm
0.3G/Piece(Non-sterile)	2000piece/bag,16bags/ctn	64 x 58 x 46cm
0.5 G/Piece(sterile)	50piece/bag,400bags/ctn	64 x 58 x 46cm
0.5 G/Piece(sterile)	100piece/bag,200bags/ctn	64 x 58 x 46cm
0.5G/Piece(Non-sterile)	1000piece/bag,20bags/ctn	64 x 58 x 46cm
0.5G/Piece(Non-sterile)	2000piece/bag, 10bags/ctn	64 x 58 x 46cm
2 G/Piece(sterile)	50piece/bag,100bags/ctn	64 x 58 x 46cm
2 G/Piece(sterile)	100piece/bag,50bags/ctn	64 x 58 x 46cm
2 G/Piece(Non-sterile)	1000piece/bag, 5bags/ctn	64 x 58 x 46cm
2 G/Piece(Non-sterile)	2000piece/bag,1bags/ctn	46 x 40 x 38cm



**GT075-100  
Eye Pads, Oval Form**

Material: Cotton filled  
Cover: Gauze or Non-woven  
Type: Self-adhesive or without adhesive  
Size: 5cm x 6cm, 8cm x 6 cm...etc  
Sterile or Non-sterile is available  
Packing:  
Size: 5cm x 6cm, 1pc/pouch, 50 pouch/ inner box, 20box/ctn, Dim:46 x 42.5 x 20cm;  
Size: 8cm x 6cm, 1pc/pouch, 50 pouch/ inner box, 20box/ctn, Dim:57.5 x 46 x 20cm;  
Size: 8cm x 6cm, 25pcs/ pack, 40pack/ctn, Dim: 42 x 2

**GT074-200  
Gauze Ball**

Specification:40's, 18x14mesh or 19x11mesh or 19x15mesh or 24x20mesh or 26x18mesh etc. are available.  
Size: Dia.3cm or Dia.4cm or Dia.5cm are available.  
Shape:Ball shape or peanut shape are available.  
Color: pure white, green, blue are available.



**GT077-300  
Cotton Swab (plastic Stick)**

Specification: Single Tip For Medical Use  
Material of The Stick: PP, PS(can Break It Off)  
Diameter of The Plastic Stick: 2.5mm-4.0mm  
Length of The Plastic Stick: 75mm-400mm  
Diameter of The Cotton Tip: 4- 15mm  
Length of The Cotton Tip: 15-50mm

3" 100pcs/bag 10bags/box, 20boxes/ctn, 47 X 37 X 23cm<sup>3</sup>  
6" 100pcs/bag 10bags/box, 20boxes/ctn, 43 X 37 X 37cm<sup>3</sup>  
6" 50pcs/bag 20bags/box, 8boxes/ctn, 63 X 37 X 49cm<sup>3</sup>  
8" 50pcs/bag 20bags/box, 8boxes/ctn, 63 X 37 X 58cm<sup>3</sup>

**GT076-100  
Cosmetic Cotton swabs**

Material: 100% Super Absorbent cotton, and 100%  
Introduction: Made from 100% Super Absorbent cotton or 100% natural paper fibre, the material is very soft, purifying with High temperature, which is used for cleaning the wound or dressing.  
Shape: Round, or Square,  
Type: Plain, lattice and flower pattern, Concavo-convex dot,... and so on.  
Size  $\phi$ 5.5cm,  $\phi$ 6.0cm 6cm x 6cm, 7.5cm x5cm  
Packing:80pcs x2/ Sealed plastic bag, 100pcs/ Sealed plastic bag, 100pcs/ inner box... or other package per customer's demand.  
Normal Package:  
Size:  $\phi$ 6.0cm(Round), 100 pcs/plastic bag, 100bag/ctn, Dim:62x32x38cm  
Size: 6.0cm x 6.0cm(Square), 100 pcs/plastic bag, 100bag/ctn, Dim:62x32x38cm





CE Approved

# Wound Dressing





**GT087-100**

**Spandex Elastic Bandage**

Material: 85% cotton With 15% spandex  
 Crepe or Plain  
 Color: natural, Flesh or Bleach  
 Weight: 75g/m2, 80g/m2, 85g/m2, 90g/m2 Etc.  
 Width: 2", 3", 4", 5", 6" etc.  
 Length: 4m, 4.5m, 5m, 6m Etc.  
 Sterile or Non-sterile  
 Packing: 1roll/poly Bag, 12roll/bag



**GT088-100**

**PBT Elastic Bandage**

Material: 65% cotton With 35% polyester  
 Color: Bleach  
 Weight: 28g/m2, 29g/m2, 30g/m2 Etc.  
 Width: 2", 3", 4", 5", 6", etc.  
 Length: 4m, 4.5m, 5m, 6m Etc.  
 Sterile or Non-sterile  
 Packing: 1 roll/poly Bag, 12 roll/bag



**GT089-100**

**Cotton Elastic Bandage**

Material: 100% cotton  
 Color: Bleach  
 Weight: 75g/m2, 80g/m2, 85g/m2, 90g/m2 Etc.  
 Width: 2", 3", 4", 5", 6", etc.  
 Length: 4m, 4.5m, 5m, 6m Etc.  
 Sterile or Non-sterile  
 Packing: 1roll/poly Bag, 12roll/bag



**GT090-100**

**High Elastic Bandage**

Material: 62% cotton With 38% polyester  
 Color: Bleach, Natural  
 Weight: 80g/m2, 100g/m2 Etc.  
 Width: 2", 3", 4", 5", 6", etc.  
 Length: 4m, 4.5m, 5m, 6m Etc.  
 Sterile or Non-sterile  
 Packing: 1roll/poly Bag, 12roll/bag

**GT102-170 Net bandage**

Material: Acrylic with Elastic  
 Color: White  
 Weight: 120g/m2  
 Size : 0.8cmx25m, 1.7cmx25m, 2cmx25m,  
 2.2cmx25m, 2.6cmx25m, 3.8cmx25m,  
 4.4cmx25m, 5.5cmx25m, 6.8cmx25m, 8cmx25m



**GT172-300 Stockinet Bandages**

Material: 100% Cotton  
 Color: Natural white, or other color per customer's demand  
 Introduction: Made from 100% natural cotton, which is used for the wound and sport. It can be made into roll.  
 Size: 5.0cm x20 m, 6.0cm x20 m, 7.5cm x20 m, 8.0cm x20 m, 10cm x20 m, 15cm x20 m,



### GT091-102

#### Non-woven Self-adhesive Bandage

Material: Non-woven PP

Color: White, blue, green, red, brown, yellow Etc.

Weight: 35g/m<sup>2</sup>, 40g/m<sup>2</sup>, 45g/m<sup>2</sup> Etc.

Width: 2", 3", 4", 5", 6", etc.

Length: 4m, 4.5m, 5m, 6m Etc.

Sterile or Non-sterile

Packing: 1 roll/poly Bag, 12 roll/box



### GT091-103

#### Cotton Self-adhesive Bandage

Material: Cotton

Color: White, blue, green, red, brown, yellow Etc.

Weight: 75g/m<sup>2</sup>, 80g/m<sup>2</sup>, 85g/m<sup>2</sup> Etc.

Width: 2", 3", 4", 5", 6", etc.

Length: 4m, 4.5m, 5m, 6m Etc.

Sterile or Non-sterile

Packing: 1 roll/poly Bag, 12 roll/box



### GT092-100

#### Plaster Of Paris Bandage

Material: Cotton With Plaster

Color: White

Weight: 390g/m<sup>2</sup>, 400g/m<sup>2</sup>, 410g/m<sup>2</sup> Etc.

Width: 2", 3", 4", 5", 6", etc.

Length: 4m, 4.5m, 5m, 6m Etc.

Sterile or Non-sterile

Packing: 1 roll/poly Bag, 12 roll/box



### GT091-101

#### Self-adhesive Elastic Bandage

Material: Cotton With Spandex

Crepe or Plain

Color: White, Skin

Weight: 75g/m<sup>2</sup>, 80g/m<sup>2</sup>, 85g/m<sup>2</sup>, 90g/m<sup>2</sup> Etc.

Width: 2", 3", 4", 5", 6", etc.

Length: 4m, 4.5m, 5m, 6m Etc.

Sterile or Non-sterile

Packing: 1 roll/poly Bag, 12 roll/box



**GT096-100**

**Zinc oxide plaster**

Material: 10% Zinc oxide with 90% hot melt adhesive  
 Color: White, Flesh.  
 Weight of adhesive: 80-85g/m<sup>2</sup>  
 Width: 1.25cm, 2.5cm, 5cm, 7.5cm, 10cm etc.  
 Length: 5m, 10m etc.  
 Packing: Plastic can, Tinplate or simple packing.



**GT097-100**

**Non-woven surgical tape**

Material: Non-woven with adhesive  
 Color: White, Flesh.  
 Weight of adhesive: 30-32g/m<sup>2</sup>  
 Width: 1.25cm, 2.5cm, 5cm, 7.5cm, 10cm etc.  
 Length: 5m, 5y, 10y etc.  
 Packing: Plastic can, Plastic cutter or simple packing.



**GT098-100**

**PE surgical tape**

Material: Polyethylene with adhesive  
 Color: Transparent  
 Weight of adhesive: 30-34g/m<sup>2</sup>  
 Width: 1.25cm, 2.5cm, 5cm, 7.5cm, 10cm etc.  
 Length: 5m, 5y, 10y etc.  
 Packing: Plastic can, Plastic cutter or simple packing.



**GT099-100**

**Silk surgical tape**

Material: Silk with adhesive,  
 Drilled or non-drilled is available  
 Line shape or zig shape is available  
 Color: White  
 Weight of adhesive: drilled 50-54g/m<sup>2</sup>,  
 Non-drilled: 32-34g/m<sup>2</sup>  
 Width: 1.25cm, 2.5cm, 5cm, 7.5cm, 10cm etc.  
 Length: 5m, 5y, 10y etc.  
 Packing: Plastic can, simple packing.



**GT100-100 Wound adhesive plaster**

Material: PVC, PE, PU, Cotton, Elastic, Non-woven etc.  
 Color: White, Flesh, etc.  
 Weight of adhesive: 32-40g/m<sup>2</sup>  
 Shape: Round, Square, Rectangle, Butterfly etc.  
 Size:  $\phi$  22,  $\phi$  25, 40x10mm, 38x38mm, 60x19mm, 72x19mm, 76x19mm, 76x38mm, 114x50mm etc.  
 Packing: 50pcs/box or 100pcs/box, 100box/carton

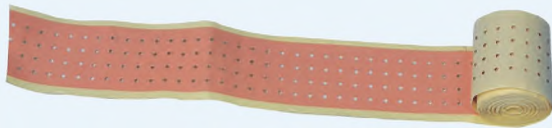

**GT101-100 Drilled plaster**

Material: Drilled Zinc oxide with hot melt adhesive.  
 Waterproof or non-water proof is available  
 With drug or without is available Color: White, Flesh.  
 Weight of adhesive: 60-65g/m<sup>2</sup>  
 Width: 2.5cm, 5cm, 7cm, 10cm, 12cm etc. Length: 1m, 5m etc.  
 Packing: 1 roll/box, 80roll/carton

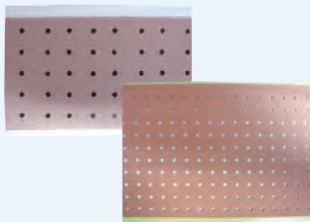

**GT101-200 Healing Capsicum Plaster**

Capsicum plaster uses the full cotton cloth as the raw material, which was coated on capsicum consisted zinc oxide adhesive. Capsicum plaster can make the partial skin generate physical reaction to accelerate blood fluxion. This plaster has drilled type and not-drilled type. All the products adopt the anti-sticky paper and film as the interleaver. Can be used by one piece or cut size conveniently and easily.



**GT096-200 Sports tape**

Ideal for sport protection, water proof, permeability. different colors available.  
 Size available: 2.5cm X 10y, 3.8cm X 10y, 5cm X 10y, 2.5cm X 15y, 3.8cm X 15y, 5cm X 15y  
 Packing: 4rolls/box, 300box/ctn,  
 dimension: 34.5 X 26.5 X 28cm



**GT174-100 Ice Bandage**

Ice wrap is a cold bandage which uses a revolutionarily new technique for treating injuries, muscle pain and strains. This bandage reduces recovery time from injuries by combing both the cooling and compressing process in an easy-to-use way. A specially formulated solution is infused into the elastic bandage that begins to evaporate upon contacting skin, thereby causes cooling of the applied area. Icewrap reduces swelling and provides sufficient cooling to make it a very effective treatment.

Sizes available:

10cm X 3.2m	120rolls/ctn	66 X 33 X 26cm
7.5cm X 3.2m	120rolls/ctn	66 X 33 X 26cm
10cm X 3.2m	48rolls/ctn	36 X 27 X 42cm
7.5cm X 3.2m	80rolls/ctn	36 X 27 X 42cm

**GT102-150 PU adhesive tape**

Material: Polyurethane film  
 Available in line shape or zig shape  
 Color: transparent  
 Size: 5x1000cm, 10x1000cm, 15x1000cm, 20x1000cm etc.  
 Packing: 100rolls/carton, 50rolls/carton

**GT102-160 Fiberglass casting tape**

Material: Fiberglass  
 Size: 5cmx360cm, 7.5cmx360cm, 10cmx360cm,  
 12.5cmx360cm, 15cmx360cm etc.  
 Packing: 1pc/ Aluminum Foil Bag 50pcs/box 100box/carton

**GT102-110****Self-adhesive wound dressing**

Material: PU, Non-woven, etc.  
 Color: White, Flesh, etc.  
 Weight of adhesive: 70-75g/m<sup>2</sup>  
 Shape: Round corner, Square corner,  
 With mat or without is available.  
 Size: 5cmx7cm, 6cmx8cm, 10cmx10cm,  
 10cmx12cm, 10cmx15cm, 10cmx20cm,  
 10cmx25cm, 10cmx30cm, 10cmx35cm etc.  
 Packing: 50pcs/box

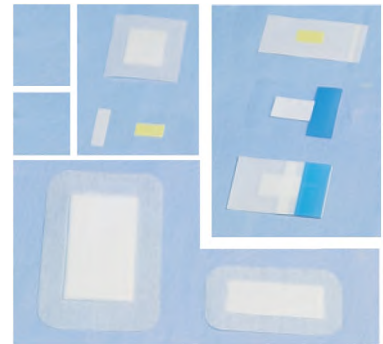
**GT102-120****Infusion plaster**

Material: Non-woven  
 Color: White, Flesh.  
 Weight of adhesive: 30-32g/m<sup>2</sup>  
 Shape: Rectangle  
 Size: 70x25mm, 70x35mm etc.  
 Packing: 100pcs/box 100box/carton

**GT102-130****Self-adhesive eye pad**

Material: Non-woven  
 Color: White, Flesh.  
 Weight of adhesive: 30-32g/m<sup>2</sup>  
 Shape: Oval  
 Size: 80x50mm, 85x55mm, 95x65mm etc.  
 Packing: 50pcs/box 100box/carton

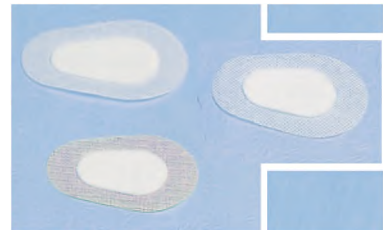
**GT102-140****Non-adherent pad**

Material: 70% Viscose with 30% Polyester  
 Color: White  
 Shape: Round, Square, Rectangle  
 Size: 5x5cm, 10x10cm, 15x15cm, 20x20cm etc.  
 Packing: 100pcs/box 100box/carton





**GT124-200**  
**Sponge Clean Stick**

1# 18cm Flat Stick 20pcs/bag, 40bags/ctn 53 X 52 X 41cm  
 2# 15cm Flat Stick 20pcs/bag, 40bags/ctn 44 X 34 X 42cm  
 3# 10cm Circinal Stick 50pcs/bag, 20bags/ctn 47 X 16.5 X 40cm



**GT086-100**  
**Alcohol Prep Pad**

Contents: 70% Isopropyl Alcohol Non-woven  
 Size : 65x30mm, 65x58mm,  
 140 X 180mm or Other Size Per Customer's Demand.  
 Type : 1Ply, 2Ply, 4Ply ,etc.  
 Packet Size : 50 X 50 mm, 60x85mm, etc.  
 Packing Quality : 1Pc/Airtight Pack. 200 Pcs / Box,  
 20000 Pcs/Ctn, 55 X 49 X 31cm



**GT086-200**  
**Povidone-ioding Prep Pad**

Contents: 10 % Povidone-iodine Solution Non-woven Size : 65 X 30mm, 65x58mm  
 or Other Size Per Customer's Demand. Type : 1Ply, 2Ply, 4Ply, etc.  
 Packet Size : 50 X 50 mm, etc. Packing Quality : 1Pc/Airtight Pack, 200 Pcs / Box,  
 20000 Pcs/Ctn, 55 X 49 X 31cm



**GT086-300**  
**Adhesive Tape Remover Pad**

Contents: Adhesive Tape Remover Pad  
 Non-Woven Size : 65 x 30mm Packet Size : 50 X 50 mm  
 Packing Quality : 100 Pcs / box, 200pcs/box, 50boxes/carton 53x24x29cm



**GT086-500**  
**Sting Relief**

Sting relief used in wiping the skin area where was stung by mosquito,  
 bee and other insects for relief of pain and itch.  
 30 X 60mm X 2 non-woven pad wrapped in a foil paper sachet sized 50 X 50mm  
 Packing: 100pcs/box, 100boxes/ctn  
 Dimension: 54 X 23 X 28cm



**GT086-400 Povidone-iodine Swabstick**

10% Povidone-iodine  
 Plastic Stick  
 1pc/pack



**GT085-100**  
**Paraffin Impregnated Gauze Pad**

Description features: Sterile Paraffin Gauze Dressings  
 are made of 100% cotton gauze swabs impregnated with white soft paraffin.  
 Their multi-trulle structures are indicated as a primary wound contact dressing for  
 treatment of burns, ulcers and skin grafts. Sterile Paraffin Gauze Dressings are  
 manufactured from highly-absorbent Gauze Swabs which have folded edges  
 and thus prevent loose fibres and shredding.  
 Size: 10cm x 10cm etc. Packing: each piece in foil pouch,  
 10 pouch/ inner box, 100pcs/ctn,  
 Dim: 62 x 28 x 32cm, G.W.: 8.0kgs, N.W.: 7.0kgs



**GT082-100**

**First-Aid bandage**

Cotton filled Size: L, M, S  
 Packing: Vacuumize  
 Packing: Size: Small, 1pc/ Vacuumize pack, 400 pack/ctn, Dim: 50 x 32 x 36cm  
 Size: Medium, 1pc/ Vacuumize pack, 400 pack/ctn, Dim: 50 x 44 x 36cm  
 Size: Large, 1pc/ Vacuumize pack, 400 pack/ctn, Dim: 50 x 46 x 43.5cm



**GT004-136 Thermometer cover**

Material: PE  
 Description: Insert, twist, pull apart or peel back covers  
 Packing: 200pcs/box, 150box/carton  
 Carton Dimension: 38x32x32cm



**GT083-100 Triangle Bandage**

Material: 100% cotton or Rayon Fabric  
 Cotton Yarn: 40 x 34, 50 x 30, 48 x 48 etc.  
 Size: 36" x 36" x 51", 40" x 40" x 56"  
 With or without safety pin Colored: Grey or Bleached.  
 Packing: 1 pc/ sealed poly bag, 240bag/ctn,  
 Dim: 45 x 38 x 22cm,  
 G.W.: 6.5kgs, N.W.: 5.0kgs

**GT079-100 O. R. Towel**

Material: 100% cotton, Pre-washed or Non-washed.  
 Standard weight: 200Gram/M2 and 250Gram/M2  
 or other gram per customer' demand.  
 Color: Blue  
 Standard opened size: 43x66cm (± 2cm)  
 or other size per customer' demand  
 Packing: Sterile package or In bulk



**GT064-100 Drape With Hole**

Material: PU or IO Drape  
 PU drape is a transparent, adhesive polyurethane film, which can adhere throughout long surgical operations to the surrounding skin and most importantly to the wound edge, thereby significantly lessening the chance of compromising the sterile environment. IO Drape is an enhanced surgical drape product that is impregnated with iodophor P.V.P. Iodrape helps to maintain a sterile barrier, lowers the risk of microbial transmission, and significantly lowers the colony forming units (CFU's) of the bacteria staphylococci during use in operations. The need for the enhanced product is especially useful for the following operations: Orthopedic procedures, cardiac valve replacements, venous retention suture <needle>, peritoneal <enceheiresis> therapy, and by-pass operations of the cerebrospinal fluid.

**Features:**

- Breathable
- Transparent and thin
- Conformable and elastic
- Easily applied to the skin
- Sterilization: EO
- SIZE: 50cmx50cm, 70cmx90cm, 70cmx110cm, 150cmx200cm or other size per customer' demand





# DENTAL



## GT081-100 Dental Sponges

Cotton filled  
Cotton Yarn: 40's x 40's, 32' x 32'  
Mesh: 19 x 9, 20 x 12 etc.  
Size: 2" x 2", 3" x 3", 4" x 4" etc.  
Ply: 8ply etc  
Sterile or non-sterile  
Packing: 100pcs/ pack, 50pack/ctn  
Size: 2" x 2" x 8 ply, 100pcs/pack,  
50 pack/ctn, Dim:: 52 x 42 x 45cm;  
Size: 3" x 3" x 8 ply, 100pcs/pack,  
50 pack/ctn, Dim:: 52 x 50 x 30cm;  
Size: 4" x 4" x 8 ply, 100pcs/pack,  
50 pack/ctn, Dim:: 52 x 52x 40cm;



## GT080-100 Dental Cotton Rolls

Description: 100% Cotton, natural,  
super Absorbent  
**A: 20g/bundle, Dia: 7cm**  
φ 0.8cm X L3.8cm, 56pcs/bundle,  
75bundles/ctn  
φ 1cm X L3.8cm, 41pcs/bundle,  
75bundles/ctn  
φ 1.2cm X L3.8cm, 30pcs/bundle,  
75bundles/ctn  
φ 1.4cm X L3.8cm, 23pcs/bundle,  
75bundles/ctn  
Packing: 36 X 22 X 20cm  
**B. 25g/bundle, Dia: 7.2cm**  
φ 0.8cm X L3.8cm, 60pcs/bundle,  
40bundles/box, 12boxes/ctn  
φ 1cm X L3.8cm, 50pcs/bundle,  
40bundles/box, 12boxes/ctn  
φ 1.2cm X L3.8cm, 38pcs/bundle,  
40bundles/box, 12boxes/ctn  
Packing: 61 X 47 X 43cm



## GT165-100 Salive Ejector

Material: PVC  
Length: 15cm  
Packing: 100pcs/bag,  
10bags/ctn, 31.5X24X16cm



## GT078-100 Surgical Hand Brush

with/ without Iodine



## GT078-200 iodine brush

iodine brush used for sterilization  
before a surgery



## GT094-100 Dental tray

- Content Of The Set:
1. Plastic Tray
  2. Periodontal Probe With Plastic Handle
  3. Choice Of A Plastic-handle Tweezers (stainless Metal Points)  
Or A Metal-handle Tweezers Or Forceps.
  4. Plastic Stomatoscope, Glass Mirror. Or Pc Mirror, abs Handle.
  5. Dental Bib.
  6. Additional Supplies Such As A Saliva Ejector, Gel Tray,  
Gauze Swabs, Cotton Balls, Dental Brush,
  7. Dental Cotton, Mask, etc.  
Can Be Assembled To The Individual's Specifications.
  8. Packing: 1 Set/plastic Bag, 200sets/ctn, 61x41x39cm,  
G.W.: 12kg N.W.: 10kg
  9. Packing: 1 Set/blister Bag, 480sets/ctn, 61 x 47.5 x 41.5,  
G.W.: 13kg N.W.: 12kg
  10. Sterilized With E.o.gas.
  11. Expiration Date: 2 Years.



GT094-200A

GT094-200B

## GT094-200A / GT094-200B Dental Bib

Item: Disposable Bibs  
Material: 2 X 20g Paper Laminated 20g Pe Film  
Size: 33 X 46cm, 33 X 66cm Or 40 X 45cm  
Color: White /green / Pink/blue/green/purple  
Packing: 125pcs/bag, 4bags/ctn, 37 X 34.5 X 26.5cm,  
G.W.: 4.5kg, N.W.: 4.2kg



**GT095-100 Basic Dressing Set 1 (paper-plastics Compound Bag)**

100bags/ctn, 47 X 31 X 41cm

- 1pc Dressing Tray
- 5pcs Cotton Wool Balls 05gm
- 5pcs Gauze Swab 7.5cm X 7.5cm-5pcs
- 3pcs Dressing Forceps
- 1pc Surgical Drape
- 1pc Hand Towel
- 1pc Limpet Bag
- 1pc Sterile Field



**GT095-200 Basic Dressing Set 2(shrink Bag)**

200bags/ctn, 63x29x34cm

- Item: 1pc Dressing Tray
- 8pcs Cotton Wool Balls 0.5gm
- 5pcs Gauze Swab 7.5cm X 7.5cm-5pcs
- 3pcs Dressing Forceps
- 1pc Surgical Drape
- 1pc Sterile Field



**GT095-300 Basic Dressing Set 3(blister Bag)**

Item: 1pc Dressing Tray

- 6pcs Gauze Balls
- 2pcs Dressing Forceps
- 1pc Surgical Drape
- 1pc Hand Towel

Wound Dressing



**GT095-301 Dressing set**

120bags/ctn, 41 X 34 X 34cm

- 1pc Forcep 4#
- 1pc Surgical blade
- 3pcs Gauze swab 5cmx5cm



**GT095-302 Dressing set**

40bags/ctn, 38 X 29 X 28cm

- 1pc PE+PAPER 33x45cm
- 2pc Forcep 4#(blue and green)
- 5pcs 40g/m2(D3cm) 0.8G Non-woven ball



**GT095-303 Dressing set**

40bags/ctn, 38 X 29 X 28cm

- 1pc PE+PAPER 33x45cm
- 2pc Forcep 4#(blue and green)
- 5pcs 20x20cm(28x24mesh) 1.2G Gauze ball
- 5pcs Non-woven swab 7.5cmx7.5cm



**GT095-304 Dressing set**

200bags/ctn, 69 X 42 X 34cm

- 2pc Forcep 4#(white and green)
- 3pcs Gauze ball 28x24mesh(15x20cm)



**GT095-305 Dressing set**

40bags/ctn, 39 X 30 X 30cm

- 1pc PE+PAPER 32x45cm
- 1pc Hemostasia Scissor
- 1pc Forcep 4#
- 5pcs 20x20cm(28x24mesh) 1.2G Gauze ball
- 5pcs Non-woven swab 7.5cmx7.5cm



**GT095-306 Dressing set**

40bags/ctn, 39 X 30 X 30cm

- 1pc PE+PAPER 33x45cm
- 1pc Forcep 4#
- 5pcs 40g/m2(D3cm) 0.8G Non-woven ball



**GT124-100 Plastic Forceps**

- 1# 10.8cm 200pcs/bag, 25bags/ctn, 64 X 46 X 46cm
- 2# 14cm 200pcs/bag, 20bags/ctn, 64 X 46 X 46cm
- 3# 11.5cm 200pcs/bag, 10bags/ctn, 51 X 32 X 35cm
- 4# 12.5cm 200pcs/bag, 10bags/ctn, 50 X 42 X 30cm
- 5# 18cm 1000pcs/bag, 50 X 38 X 42cm
- 6# 10.8cm 200pcs/bag, 25bags/ctn, 64 X 46 X 46cm



**GT124-200 Hemostasis Pincers**

Size:length14cm X width7.5cm  
 Material:ABS and nylon are available.  
 ABS for EO sterilization,  
 nylon material for high temperature steam sterilization.  
 Color:blue,green,black,red etc. are available.  
 Packing:individual sterile blister pack  
 MOQ:20000pcs/color

# FIRST-AID

## GT158-301 First Aid Kit

Materials: 600D oxford

Size: 32X22X7cm

Can be configured according to customer requirements

Packing: 20pcs/ctn, 81X34X47cm

### Recommended Configuration:

Item	Specification
ICE Bag	160g
PVC Gloves	M, powdered, nature
Non-Woven Surgical Tape	1.25cmx5y, white, simple packing
Non-Woven Surgical Tape	5cmx5y, white, simple packing
Wound Adhesive Plaster	72x19mm, PVC, brown color
PBT Elastic Bandage	3"x4m, bleach, cellophane packing
PBT Elastic Bandage	5cmx4m, cellophane packing
Gauze Bandage	5cmx5m
Gauze Bandage	7.5cmx5m
Triangular Bandage	Mesh 46x30, 36"x36"x51"
Breathing Mask With One-Way Valve	20cmx20cm
Sterile Gauze Swab	24x20, 10cmx10cmx12p, 5pcs/bag
Sterile Gauze Swab	24x20, 7.5cmx7.5cm x12p, 5pcs/bag
Applicator	3", 6pcs/bag
Cotton Wool	3pcs/roll
Alcohol Prep Pad	65x30mmx2ply
Scissor	
Tweezer	4#

Wound Dressing





### GT158-302 First Aid Kit

Materials: 420D oxford

Size: 21X13X6cm

Can be configured according to customer requirements

Packing of First Aid Kit: 180pcs/ctn, 62X46X30cm

#### Recommended Configuration:

Item	Specification	Quantity
ICE Bag	160g	1 pc
Non-Woven Surgical Tape	1.5cmx5y, white, simple packing	1 roll
Wound Adhesive Plaster	72x19mm,PVC, brown color	10 pcs
PBT Elastic Bandage	3"x4m,bleach, ,cellophane packing	1 roll
Gauze Bandage	5cmx5m	1 roll
Gauze Bandage	7.5cmx5m	1 roll
Triangular Bandage	Mesh 46x30, 36"x36"x51"	1 pc
Breathing Mask With One-Way Valve	20cmx20cm	1 pc
Sterile Gauze Swab	24x20,7.5cmx7.5cmx12p,5pcs/bag	1 bag
Applicator	3",6pcs/bag	1 bag
Cotton Wool	3pcs/roll	1 roll
Alcohol Prep Pad	65x30mmx2ply	10 pcs
Scissor	—	1 pc
Tweezer	4#	1 pc

### GT158-303 First Aid Kit

Materials: 600D oxford

Size: 23X18X14cm

Packing: 10pcs/ctn, 48.5X38.5X31 cm

#### Recommended Configuration:

Item	Specification
ICE Bag	160g
PVC Gloves	M, powdered, nature
Non-Woven Surgical Tape	1.25cmx5y, white, simple packing
Non-Woven Surgical Tape	5cmx5y,simple packing
Wound Adhesive Plaster	72x19mm,PVC, brown color
PBT Elastic Bandage	3"x4m, bleach, cellophane packing
PBT Elastic Bandage	5cmx4m, cellophane packing
Gauze Bandage	5cmx5m
Gauze Bandage	7.5cmx5m
Triangular Bandage	Mesh 46x30, 36"x36"x51"
Breathing Mask With One-Way Valve	20cmx20cm
Sterile Gauze Swab	19x15,7.5cmx7.5cm x12p,5pcs/bag
Sterile Gauze Swab	24x20,7.5cmx7.5cm x12p,5pcs/bag
Applicator	3",6pcs/bag
Cotton Wool	3pcs/roll
Alcohol Prep Pad	65x30mmx2ply
Scissor	—
Tweezer	4#



### GT158-304 First Aid Kit

Materials: White huayao ethnic group

Size: 11X7X4cm

Can be configured according to customer requirements

Packing: 200pcs/ctn, 53X47X50cm

#### Recommended Configuration:

Item	Specification
Non-Woven Surgical Tape	1.25cmx5y, white, simple packing
Wound Adhesive Plaster	72x19mm,PVC, brown color
PBT Elastic Bandage	5cmx4m, cellophane packing
Applicator	3", 6pcs/bag
Cotton Wool	3pcs/roll
Triangular Bandage	Mesh 40x34, 36"x36"x51"
Alcohol Prep Pad	65x30mmx2ply





**GT158-306 First Aid Kit**

Materials: 420D Oxford

Size: 15X12X5cm

Can be configured according to customer requirements

Packing: 50pcs/ctn, 37.5X46.5X31cm

**Recommended Configuration:**

Item	Specification
Non-Woven Surgical Tape	1.5cmx5y, white, simple packing
Wound Adhesive Plaster	72x19mm,PVC, brown color
PBT Elastic Bandage	3"x4m,bleach, ,cellophane packing
Gauze Bandage	5cmx5m
Gauze Bandage	7.5cmx5m
Triangular Bandage	Mesh 46x30, 36"x36"x51"
Applicator	3",6pcs/bag
Alcohol Prep Pad	65x30mmx2ply
Scissor	
Tweezer	4#



**GT158-307 First Aid Kit**

Materials: 420D Oxford

Size: 12X9X5.5cm

Can be configured according to customer requirements

**Recommended Configuration:**

Item	Specification
ICE Bag	160g
Non-Woven Surgical Tape	1.5cmx5y, white, simple packing
Wound Adhesive Plaster	72x19mm,PVC, brown color
PBT Elastic Bandage	3"x4m,bleach, ,cellophane packing
Gauze Bandage	5cmx5m
Gauze Bandage	7.5cmx5m
Triangular Bandage	Mesh 46x30, 36"x36"x51"
Breathing Mask With One-Way Valve	20cmx20cm
Sterile Gauze Swab	24x20,7.5cmx7.5cmx12p,5pcs/bag
Applicator	3",6pcs/bag
Cotton Wool	3pcs/roll
Alcohol Prep Pad	65x30mmx2ply
Scissor	
Tweezer	4#

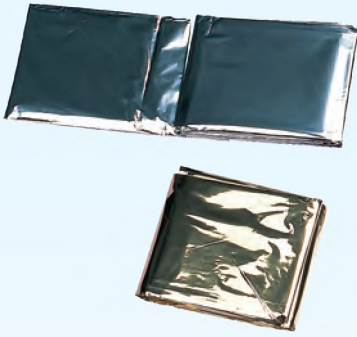

**GT084-100 Thermal Accident Blanket**

Material: PET Film

Waterproof, use to offset hypothermic reactions, reflective surface provides high visibility, reflects sun and heat for cooling in hot climates, space-age design retains up to 90% of body heat, assists in prevention of post-accident shock and first aid application.

Size: 132x210, 140x220cm, 160x 210cm or other size per customer' demand

Color: Gold, Silver, Gold + Silver Packing: Each piece in sealed poly bag, 250pcs/ carton;

Size: 132cm x 210cm, 250 pcs/ctn, Dim: 41 x 24 x 32cm, G.W.:15.5kgs, N.W.: 13.5kgs;

Size: 140cm x 220cm, 250 pcs/ctn, Dim: 41 x 24 x 35cm, G.W.:16.5kgs, N.W.: 14.5kgs;

Size: 160cm x 210cm, 250 pcs/ctn, Dim: 42 x 23x 40cm, G.W.:17.0kgs, N.W.: 15.0kgs;



**GT093-100 Splints**

Aluminum plate Macromolecule foam material Nontoxic and nonbenzenoid Free of effect of temperature and climate Type available: Fold, Unfold and Roll

Normal size: 5cmx12cm, 5cmx15cm, 7cmx11cm,

11cmx44cm, 11cmx91.5cm, 11cmx100cm



**GT167-101 Sterile Delivery Pack**

Non-woven surgical gown-1PC;

86x80cm Packing Clothes 2ply(Non-woven and thin film)-1PC;

97x73cm Sheet 3ply(Thin film, non-woven and paper pulp)-1PC;

97x73cm Triangle Trousers 3ply(Thin film, non-woven and paper pulp)-2PCS;

66x43cm Non-woven Cloth 2ply(Thin film and non-woven)-2PCS;

66x43cm Non-woven Cloth 1ply-1PC; Umbilical Cord Clamp-1PC;

8cm Cotton sticker-2PCS; PE glove-1PAIRS; Latex examination glove-1PAIRS;

8x10cm Gauze swab-5PCS; Face mask-1PC; Cap-1PC



# Disposable Hospital Uniform



### GT058-101 Round Nurse Cap

**Description:**

Manufactured From High Quality Non-woven Polypropylene Lightweight, Cool, Comfortable Material – Soft Elastic Headband Suited To Lab, industry, Hospital And Daily Home Use.

**Specification:**

Non Woven PP Material :  
 10g, 12g; 14g; 16g; 18g;  
 Available In 18" ,21" or 24" Sizes,  
 White, Green or Blue, Pink, Yellow, Red... etc.  
 Sterile Method : None or Eo Sterile  
 Packing: 100pcs/Poly Bag 10Bags/Carton  
 carton size: 240x240x340mm



### GT058-201 Clip Cap

**Description:**

Manufactured From High Quality Non-woven Polypropylene High Quality Material For Increased Durability Convenient Dispenser Lightweight, Cool, Comfortable Material – Soft Elastic Headband , and Comfortable Fold Type Suited To Lab, Industry, Hospital and Daily Home Use.

**Specification:**

Non Woven PP Material: 10g; 12g; 14g; 16g, etc  
 Color: White, Green, Blue , Pink , Red, Yellow  
 Size: 20", 21" , 24"  
 Type: Single Elastic / Double Elastic  
 Sterile Method : None or EO Sterile  
 Packing: 100pcs/Poly Bag 10Bags/Carton  
 carton size: 530x240x350mm



### GT058-301 Doctor Cap

**Description:**

Manufactured From High Quality, Soft, Non-woven PP Material, High Quality Material For Increased Durability Convenient Dispenser Lightweight, Cool, Comfortable Material – Soft Elastic Headband Suited To Lab, Industry, Hospital and Daily Home Use.

**Specification:**

Non-woven PP Material; 20g, 25g, 30g, 40g  
 Color: Green , Blue  
 Type: Tie or Elastic Back  
 Size: 61x14cm ; 64x23cm etc.  
 Latex Free  
 The SMS , Spun Lace Fabric is available  
 Packing: 100pcs/ Poly Bag, 10Bags/Carton  
**Size of packing:**  
 Export carton: 50x50x30cm or 18x30x30cm  
 Gross. Weight: 7.0kgs  
 Net. Weight: 6.0kgs



### GT058-401 Net Cap

**Description:**

Made From High Quality, Nylon Net Fabric Material, High Quality Material For Increased Durability Convenient Dispenser Lightweight, Cool, Comfortable Material – Soft Elastic Headband Suited To Lab, Industry, Hospital and Daily Home Use.

**Specification:**

Nylon Net Fabric  
 Color: Blue  
 Size: 18", 21", 24"  
 Packing: 100Pcs/ Box , 10Box/Carton  
**Size of packing:**  
 Inner box: 280x260x100mm  
 Export carton : 510x290x530mm  
 Gross. Weight: 6.0 Kgs  
 Net. Weight: 5.0 Kgs





**GT059-101 Non-woven Face Mask**

**Description:**

Conforms To American Nelson N95 Test Standards. Mini-Fiber High Electrostatic Filter, Filtration Efficiency of Dust & Powder is over 95%. Repel Continually Contamination of Dangerous Blood and Saliva Continually. Inner Cover Is Well Sweat-Absorbed, While Outer Cover Is Water Resistant. Polypropylene Cloth, Low Breathing Resistance and High Filtration Efficiency.

**Specification:**

Ear-Loop Type: 1ply, 2-Ply or 3 Ply  
 Detailed Weight: 1 Ply:38g/m<sup>2</sup>, 2Ply:25g/m<sup>2</sup>+18g/m<sup>2</sup>;  
 3Ply:25g/m<sup>2</sup>+20g/m<sup>2</sup>+16g/m<sup>2</sup>;

Size: 18x9cm  
 Color:White,Green,Blue, etc.  
 Packing: 50Pcs/Box 40Boxes/Carton  
 Carton size: 420x390x370mm

Disposable Hospital Uniform

**GT059-200 Nurse Paper Face Mask**

**Description:**

Our Most Economical Face Masks ,High Quality Wet-Strength Paper Comfortable Elastic Ear Loops For Easy Donning Product Description

**Specification:**

2 Ply or 1 Ply  
 Size: 20x7cm  
 Color: White  
 Suggested Applications: Polluted Environment, Especially Good For Absorbing and Filtrating The Exhausted Gas From Motor Vehicles.  
 Packing: 100 Pcs/Box 100Boxes/Carton



**GT059-300 Dust-proof Face Mask**

**Specification:**

Conforms To FFP1 & FFP2  
 Fiberglass Free, Odorless, Non-irritating To The Skin  
 Adjustable Contoured Aluminum Nosepiece Helps To Ensure Proper Fit.  
 Low Cost And Easy To Use  
 Suggested Applications: Factory, Garden, Process,Maintain, House Cleaning, Motorcycle Riders, Wood, and Any Toxic Free Protection.  
 Non-woven PP Material:16g,18g,20g etc  
 Color:White,Blue, Dark Blue  
 Packing: 50pcs/ Inner Box ; 20Boxes/Carton

**Size of packing:**

Inner box:115x115x125mm  
 Export carton:600x260x250mm  
 Gross.Weight::4.2kgs  
 Net.Weight:3.6kgs



**GT059-120 Face Guard**

**Specification:**

Conforms To American Nelson N95 Test Standards. Ear-Loop Type: 3-Ply or 2Ply Non Woven, Polypropylene Cloth, Low Breathing Resistance and High Filtration Efficiency, and PVC Transparent Shield  
 Mini-Fiber High Electrostatic Filter, Filtration Efficiency of Dust & Powder is over 95%.  
 Repel Continually Contamination of Dangerous Blood and Saliva Continually. Inner Cover is Well Sweat-Absorbed, While Outer Cover is Water Resistant.  
 Packing: 25Pcs/ Inner Box ; 20 Boxes/Carton

**Size of packing:**

Export carton : 540x340x210mm  
 Gross.Weight::4kgs  
 Net.Weight: 3kgs





### GT058-501 Surgical Hood

**Description:**

A Disposable Surgical Hood Which Conforms To The Wearer's Head, and is Usable Either with a Traditional Surgical Mask Alone or With Such a Mask In Combination With a Laminar Air Flow Face Plate, Contains Bacterial Fallout From The Wearer's Head and Helps Maintain Sterile Conditions in Hospital Operating Rooms.

**Specification:**

Non Woven PP Material:16g,20g,25g,30g,etc

Size: 30x124cm

Color: White, Green, Blue

Packing: 100Pcs/Poly Bag ; 10Bags/Carton

**Size of packing:**

Export carton : 380x300x300mm

Gross.Weight: 7.5kgs Net.Weight: 6.2kgs



### GT058-502 New Type Dust Proof Face Mask

**Description:**

Conforms To American Nel Son N95 Test Standards.

Ear-Loop For Easy Use,160g/180g/200g ,

Low Breathing Resistance With High Filtration Efficiency.

Adjustable Nose Seal, Easy To Fold and Carry.

Special 3-Ply Design Respirator Produced From High Filtrable And Electrostatic Material With High Efficient Activated Carbon Cloth For Relief From The Irritating Effects of Nuisance Odor, Acid Gas, Hydrogen Fluoride and Ozone.

**Suggested Applications:**

Polluted Environment,

Especially Good For Absorbing and Filtrating The Exhausted Gas From Motor Vehicles.

Packing:50Pcs/ Inner Box ; 20Boxes/Carton

**Size of packing:**

inner box :115x115x128mm

Size of outer box :600x270x250mm

Gross.Weight: 5kgs Net.Weight: 4kgs



### GT059-304 N95 Face Mask (with / Without Valve)

**Specification:**

Conforms To International Standarrds:

EN149:2001 FFP1 FFP2 CE0194

AS/NZS 1716: 1994 NIOSH N95

Low Breathing Resistance With High Filtration Efficiency.

Adopted The Polypropylene Material,

Which is Without Any Toxic Chemicals or Stimulant.

Adjustable Contoured Aluminum Nosepiece and a

Soft Inner Foam Nose Cushion Help To Ensure Proper Fit And Increase Worker Comfort.

Easy-Breathing Exhalation Valve With Inner Silicon-Piece

Can Facilitate The Air Exchange and Increase Worker Comfort.

Special 3-Ply Design Respirator Produced From High Filtrable and Electrostatic Material For Resisting Normal Toxic and Tiny Micro Particle.

**Suggested Applications:**

Chemurgy, Spray-Paint/Printing,

Dyeing, Garage, Factories of Electronic Aid and Food,

Disinfecting and The Insalubrious Workshops.

Form of Packing: 20Pcs/ Inner Box ; 20Boxes/Carton

**Size of packing:**

Inner box : 120x120x260mm

Export carton: 620x260x540mm

Gross.Weight::8kgs Net.Weight:7kgs



### GT059-306 Filtering half masks

flat-folded CE EN 149:2001,

protection against solid and fluid particles (FFP1 and FFP2)

and protection against toxic particles (FFP3 only), single packed.

without valve, FFP1 / with valve, FFP2 / with valve, FFP3

Package: 20 pcs/box, 400 pcs/carton

carton size: 57x43x32cm

**GT063-100  
Surgeon Gown**

**Specification:**

Material: Non Woven PP/PP+PE/SMS  
 Color: White/Blue/Yellow/Green.  
 Weight: 40/45/50/GSM PP or SMS  
 Size: S : 110x154 cm / M : 120x150 cm  
 L : 130x155 cm / XL : 140x160 cm / XXL  
 Suited to Hospital Use. 10Pcs/Bag 100Pcs/Carton

**With Ties At Back Of The Neck And Waist**  
 Comfortable Sleeve Tailoring For Maximum  
 Freedom of Movement

Soft Knit Cuffs For Wrist Comfort  
 Secure Silve Seams For Protection  
 Extra Protection Reinforcement on Sleeve &  
 Chest and Full-body on Selected Gowns  
 Cloth Like Fabric Breathable,  
 quiet and Supple With Knitted Cuff ,  
 Vecro Neck Back Closure, Side Waist Band  
 Reinforced Arm And Additional Liner At Front Is Available.  
 1 Hand Towel Is Available

Sterile Method : Non Sterile or EO Sterile,  
 Packing: 10 Pcs/Poly Bag or 1 Pc/Sterile Bag  
**Sms Surgical Gown**

Natural Latex Free,Water Repellent,Protection  
 Against Splatter of Blood  
 Breathable,Soft

100% PP Spunbond + Meltblown(SMS)  
 Anti-static is available

**Spunlace Surgical Gown**

Anti-Bacterial,Alcohol-Repellent, Blood-Repellent  
 Waterproof Dustproof Breathable, Soft, Comfortable Mobility  
 Made From Spunlace Non Woven  
 Packing: 1Pcs/Sterile Pack 25Pcs/Carton



Disposable Hospital Uniform

**GT063-110  
Disposable Uniform Isolation Gown**

**Specification:**

Material: Offer Economical,  
 Comfortable Reliable and Protection,  
 Non Woven PP/ PP+PE  
 Full Length For Maximum Coverage, Latex Free ,  
 Sewn Seams Provide Superior Strength,  
 And Extra Length On Waist Ties Allow Gown  
 To Be Easily Secured In Front  
 With Ties at Back of The Neck and Waist  
 Color: White/Blue/Yellow/Green.  
 Weight:18/ 25/30/40GSM  
 or 18/25/30/40GSM PP + 15 PE  
 Size:115 x137cm or 120x140cm etc.

Elastic Wrist or With Knitted Cuff  
 10Pcs/Bag, 100Pcs/Carton  
 or 1 Pc/sterile Pack ; 50Pcs/Carton  
 Sterile Method: EO Sterile  
 Suited To Lab, Industry,  
 Hospital and Daily Home Use.

Form of Packing:  
 10 Pcs/Poly Bag or 1Pc/Sterile Packing  
 Packing: 10Pcs/Poly Bag 10Bags/Carton  
 Carton size: 560x320x350mm



**Ultrasound(PP+PE)**

**with Knitted cuff**

**with elastic wrist**



### GT063-150 CPE gown

This kind of CPE gown Can be used in hospital, laboratory, food industry, any where need protection.

Descriptions:

Can be used in hospital, laboratory, food industry, any where need protection. Prevent and isolate dust, particle, alcohol, blood, bacteria and virus invading. Can be used as a visit coat .Prevent te cross infection in medical treatment at sanitation field. Economical and disposable. Accord with the hygienic standard.

1.Material:CPE

2.Characteristics: prevent and isolate dust, particle, alcohol, blood, bacteria and virus invading.

3.Thumb loop wrists prevent sleeves from sliding up when putting gloves on

4.Colour:blue

Size: 125x200cm, 62g.

Package: 1 pc/bag, 100pcs/carton

Carton size: 460x200x250mm

### GT063-301 Lab Coat

**Specification:**

Material: Non Woven PP/PE

Color: White/Blue/Yellow/Green.

Weight: 30/35/40/45GSM ,

Size: M:105x130 cm / L:105x135 cm

XL:115x140 cm / XXL:115x145 cm

With Label Collar/ Knitted Collar

and 4 Press Buttons

Button Closure or Zipper Closure

or Velcro Closure

Size: M/L/XL/XXL

Suited To Hospital and Daily Home Use.

Form of Packing:10Pcs/ Inner Poly Bag ;

100Boxes/Carton

**Size of packing:**

Export carton: 560x320x420mm

Gross.Weight:12.5kgs

Net.Weight:11.0kgs



### GT063-302 Lab Coat

**Specification:**

Non Woven PP Fabric 40g, 45g

71x62cm Short Sleeve Top

4 Button Front Closure

108x56cm Pant With Elastic Band

Color: Blue

Keeping The Environment Free of Infection

and Disease Is Always a Battle

For a Health Professional,

Suited To Hospital and Daily Home Use.

Form of Packing:1Pcs/ Inner Poly Bag ;

50Boxes/Carton

**Size of Packing:**

Export Carton: 560x350x500mm

Gross.Weight:12.5kgs

Net.Weight:11.0kgs



### GT063-400

#### Disposable Scrub Coat

##### Description:

Disposable Scrub Coat are Perfect For any Medical Professional Shopping on a Budget. Available In Several Colors And Made From Quality Non Woven PP Or SMS Material, Disposable Scrub Coat Are Attractive As Well As Affordable. Suited To Hospital And Daily Home Use.

##### Specification:

Non Woven PP Or SMS Fabric:48g,55g  
V Collar Top  
Elastic Waist Pant  
Color: Green, Blue  
Unisex

Form Of Packing:1Pcs/ Inner Poly Bag ;  
50Boxes/Carton

##### Size of packing:

Export carton:430x340x550mm  
Gross.Weight:8.5kgs  
Net.Weight:7.5kgs



### GT063-500

#### Overall Gown

##### Specification:

With Head Hood & Shoe Cover and Zipper

Material: PP/ PP+PE Film / SMS

Color: White/Blue/Green/Dark

Weight: 35/45/50/60GSM

Size: M/L / XL/XXL at Clients'option

S: 164x126 cm / M: 172x130 cm

L: 178x134 cm / XL: 182x138 cm

XXL: 184x142 cm

Suited To Lab, Industrial, Agriculture,  
Hospital And Daily Home Use.

Unique One Piece Design That Cover Whole Body

Convenience And Easy To Wear And Off

Available In Standard or Pe Coated

Coverall, Zipper With Storm Flap,

Attached Hood, Boots,

Elastic Wrists, Waist & Ankles Are Aavailable

Bound Seam Construction

Packing: 1Pcs/Poly Bag 50Bags/Carton

Carton size: 480x340x410mm



### GT166-100

#### Body bag

10pcs/polybag;

20bags/ctn

42x34x40/200pcs



### GT160-100

#### Non-woven Fabric

##### Specification:

PP, SMS, Spunlace

Kinds of Gram

Kinds of Color



**GT061-100 PE Sleeve**

**Specification:**

Size 20x40cm,42x22cm,46x22cm  
 Thickness 0.02 mm /0.018mm  
 Made of PE. With Comfortable Elalstic,  
 Water Repellen,  
 Elasticized at Both Ends to Prevent Slippage  
 Fluid Resistant  
 Effective Protection For Wrist and Forearm  
 Clear, White, Blue, Red Colors etc  
 Packing: 100Pcs/Poly Bag 2000Pcs/Carton  
 carton size: 340x230x320mm



**GT062-102 CPE Shoe Cover**

**Specification:**

Color: Blue or Green .  
 Material: CPE Fabric: 1.8g, 2.0g, 2.1g, 2.5g,3.0g  
 Made of CPE, Embossed Surface .  
 with Comfortable Elastic Opening.  
 Available In Different Thickness and Color  
 Size: 36x15cm, 41x15cm, 40x16cm  
 thickness:0.02mm, 0.025mm, 0.28mm,0.035mm  
 At Clients' Option  
 Packing: 100Pcs/Poly Bag 5000Pcs/Carton  
 Carton size: 480x320x360mm



**GT062-104 High Elastic shoe cover**

Made from High Elastic non-woven Fabric.  
 Size: H23.1 X W17mm  
 Color: White,blue,green,red,brown,yellow Etc.  
 Package: 260 pcs/bag, 6 bags/carton  
 carton size: 64x47x45 cm



**GT062-101 PE Shoe Cover**

**Specification:**

Color: Blue or Green  
 Material: PE Fabric:1.6g, 1.8g, 2.0g, 2.1g, 2.5g,  
 Made of PE. With Comfortable Elalstic Opening.  
 Available in Different Thickness and Color  
 Size: 36x15cm, 41x15cm, 40x16cm  
 Thickness:0.016mm, 0.018mm, 0.02mm,  
 0.021mm, 0.025mm at Clients' option  
 Packing: 100Pcs/Poly Bag 5000Pcs/Carton  
 Carton size: 480x320x360mm



**GT062-103 Non-woven Shoe Cover**

**Specification:**

Color: White, Blue  
 Material: PP Non-woven  
**TYPE A: PP Regular Shoe Covers**  
 Comfortable Elastic Hem,Helps You Keep Your Cool.  
 Easily Worn Under A Sterile Gown. One-size-fits-most Sizing  
 Reduces Your Inventory  
**TYPE B: PP Non-skid Shoe Covers**  
 Non-skid Shoe Covers are Designed For Those Situations  
 Where Wet or Slippery Conditions Exist  
 A Proprietary Plastic Resin Is Applied To The Bottom of  
 The Cover to Improve The Wearers Traciton On The Floor  
 Weight: 30/40/45gsm at Clients' option  
 Size: 36x15cm, 38x18cm , 40x16cm  
 Packing:100Pcs/Bag 1000Pcs/Carton  
**Form of packing:**  
 100pcs/bag 1000pcs/Carton  
 Size of packing: Export carton: 520x280x350mm



**GT168-103 Disposable string**

Non Woven PP, 35 g/m2  
 one size (fits all).  
 Package: 100 pcs/bag, 10 bags/carton  
 carton size: 46x30x29 cm



**GT168-104 Disposable pant**

Non Woven PP, 35 g/m2  
 one size (fits all).  
 Package: 100 pcs/bag, 10 bags/carton  
 carton size: 46x30x33 cm

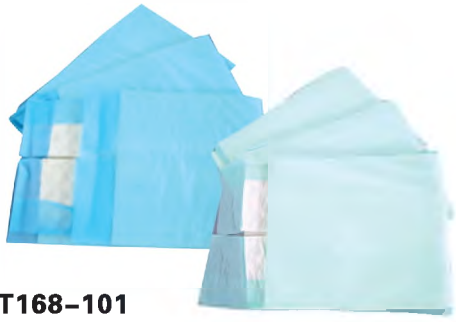

**GT168-101  
Underpad**

Material: Non-Woven fabrics + Fluff pulp+SAP + PE Film  
 Description: Color: blue  
 60X60 cm 10pcs/bag 10bags/ctn 57X22X31 cm  
 60X90 cm 10pcs/bag 10bags/ctn 42X28X42 cm



**GT064-101  
Non-Woven fabrics Bedsheet**

Description:  
 Soft touch and harmless to your skin  
 100% biodegradable and environmentally friendly  
 SPEC: light blue, 60x180cm,  
 30gsm other size and specification are also acceptable  
 PACKING: 25pcs/polybag; 4bags/ctn  
 CTN SIZE : 32x25x24 cm /100pcs



**GT064-102  
Non-Woven fabrics Bedcover**

Description:  
 disposable bed cover made of pp nonwoven fabric,  
 helps you to be clean & hygiene on your travel and regular purpose.  
 SPEC.: 30g,210x90x20cm,  
 other size and specification are also acceptable  
 PACKING: 1pc/roll;10rolls/bag, 2bag/ctn  
 CTN SIZE: 31x14x26cm /20pcs



**GT168-102  
Adult Diaper**

Specification:  
 65x80cm, with leg cuffs, waistline:71-121cm  
 65x80cm, without leg cuffs, waistline:71-111cm  
 80x96cm, with leg cuffs, waistline:96-147cm  
 80x96cm, without leg cuffs, waistline:96-137cm

Material:  
 1. Inner layer: Polyolefin Non-Woven  
 2. Absorption : Cotton Pulp, Tissue, SAP  
 3. Stopper : Adhesive tape, Frontal tape  
 4. Back sheet: Water-proof PE Back Layer  
 5. Other : Leak guard, Fabric Glue and so on  
 Features:  
 1) Wetness indicator  
 2) Super absorbent core, dry and comfortable  
 3) Refastening Frontal tape is convenient to put on and removed  
 4) PE film makes the surface dry and comfort  
 5) Super soft non-woven surface  
 6) Leak Guard prevent leakage efficiently  
 Package: 10pcs/bag, 80pc/carton  
 Carton size: 680x255x480mm



**GT060-100 PE Apron**

Specification:  
 Made of Polyethylene  
 With Adjustable Tie  
 Available In Different Size and Color  
 Thickness 0.018mm,0.020mm,0.025mm  
 Size : 110x70cm; 135x71cm;160x90cm , etc.  
 Color: White or Blue  
 Package : 100Pcs/Bag,1000Pcs/Carton  
 Packing: 10Pcs/Poly Bag 1000Pcs/Carton  
 Carton size: 360x250x180mm



**GT064-103  
Nonwoven Pillow cover**

Disposable pillow covers are used widely in hotels,  
 hospitals, home, and airline and in all travels  
 Specification:  
 80gsm,50x60cm,with 5cm gusset,  
 other size and specification are also acceptable  
 PACKING: 100pcs/polybag; 1 bag/ctn  
 CTN SIZE: 54x32x38 /100pcs

# Other Medical Products







### GT105-100 Cold Eye Mask

Item: Cold Eye Mask  
 Weight: 65G  
 Size: 64 x 7.5 cm  
 Material: outer bag: PVC  
 infilling: Glycerol+ Carboxymethyl Cellulose Sodium +  
 Preservative + distilled water  
 Packing: 120pcs/ctn, 52X23.5X22 cm,  
 G.W.:8.8kg, N.W.:7.8kg



### GT103-100 Hot Water Bag

Item: Hot Water Bag  
 Material: Calcium carbonate + ≥30% rubber  
 Description:

500CC	1pc/1 PE bag	100pcs/ctn	38X30X35cm
750CC	1pc/1 PE bag	50pcs/ctn	38X30X26cm
1000CC	1pc/1 PE bag	50pcs/ctn	38X30X28cm
1750CC	1pc/1 PE bag	50pcs/ctn	38X30X30cm
2000CC	1pc/1 PE bag	50pcs/ctn	38X30X35cm
2500CC	1pc/1 PE bag	50pcs/ctn	38X30X38cm
3000CC	1pc/1 PE bag	50pcs/ctn	38X30X42cm



### GT103-200

#### Cover for hot water bag

Cover for hot water bag made of fabric  
 All kinds of fabric are available such as furry etc  
 Size: suitable for 500ml, 1000ml, 2000ml, 2500m

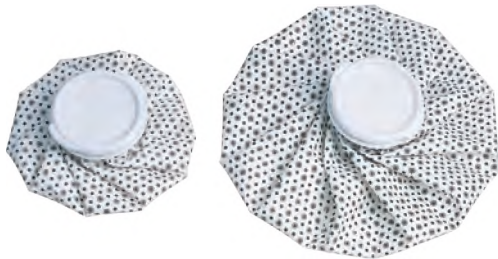

### GT104-100 Ice Bag

Material: PVC gel scrawled fabric  
 Description:

6"	1pc/1 PE bag	100pcs/ctn	38X38X35cm
9"	1pc/1 PE bag	100pcs/ctn	38X38X38cm
11"	1pc/1 PE bag	100pcs/ctn	40X38X43cm

### GT115-001 Ice Bag

Weight: 160g  
 Size: 19.5 x 12 cm  
 Material: outer bag: PE + PA infilling: carbamide + distilled water  
 Packing: 80pcs/ctn, 46X30.5X23 cm, G.W.13.8kg, N.W.12.8kg  
 Item: Disposable Ice Bag  
 Weight: 280g  
 Size: 24 x 12 cm  
 Material: outer bag: PE + PA infilling: Carbamide + distilled water  
 Packing: 50pcs/ctn, 46X30.5X23 cm, G.W.15kg, N.W.14kg



#### Usage:

Find the liquid bag in the ice bag and make it broken and 3 seconds later it will be frozen. Then shake the bag up and down to make the content fully mixed, and the temperature will be depressed below zero by the ice bag in 2 minutes.

#### Purpose:

To control and alleviate the sore and pain caused by strain, bruise, pull and burn, also can rapidly remove the pain and discomfort induced by fever, headache, toothache, mosquito bite.

Freeze and keep fresh vegetable, fruit, beer, beverage and food and so on when no cold source available.

#### Precaution:

The ice bag can only be used for external medication. If eye or skin should contact the content, it must be washed by clean water thoroughly. If one eats the content by mistake, he must drink enough water, try his best to vomit it and turn to doctor when necessary.

In order to avoid a too low temperature, it should be better to wrap the ice bag with a towel or cotton cloth to begin with. Those who have something wrong with their circulation system should refer to doctor in advance.

#### Characteristic:

This product can refrigerate instantly without cold source and be easily used because of portability.

**GT114-200****Oval ice bag**

Material: Rubber  
 Max length: 28cm  
 Max width: 17cm

**GT115-100****Instant Hot/Cold Pack**

Weight: 65g  
 Size: 10 x 10 cm  
 Material: outer bag: PVC  
 Infilling: Glycerol  
 + Carboxymethyl Cellulose Sodium +  
 Preservative + distilled water  
 Packing: 120pcs/ctn, 31.5X21.5X20 cm,  
 G.W.9KG, N.W.8KG

**GT115-101****Instant Hot/Cold Pack**

Weight: 10-20g  
 Material: outer bag: Nylon Taffeta  
 Infilling: Glycerol  
 + Carboxymethyl Cellulose Sodium  
 + Preservative + distilled water  
 Packing: 600pcs/ctn, 32X30X22 cm

Other Medical Products

**GT115-102****Instant Hot/Cold Pack**

Weight: 200g  
 Size: 20.5 x 15.5 cm  
 Material: outer bag: Nylon Taffeta  
 Infilling: Glycerol  
 + Carboxymethyl Cellulose Sodium  
 + Preservative + distilled water  
 Packing: 48pcs/ctn, 42.5X32.5X25 cm,  
 G.W.10.6kg, N.W.9.6kg

**GT115-103****Instant Hot/Cold Pack**

Item: Instant Ice Pack/Hot Pack  
 Weight: 160G  
 Size: 18.5 x 9.5 cm  
 Material: outer bag: Nylon Taffeta  
 Infilling: Glycerol  
 + Carboxymethyl Cellulose Sodium  
 + Preservative + distilled water  
 Packing: 72pcs/ctn, 37X28X18 cm,  
 G.W.12.5kg, N.W.11.5kg

**GT115-104****Instant Hot/Cold Pack**

Item: Instant Ice Pack/Hot Pack  
 Weight: 250G  
 Size: 23 x 13 cm  
 Material: outer bag: Nylon Taffeta  
 Infilling: Glycerol  
 + Carboxymethyl Cellulose Sodium  
 + Preservative + distilled water  
 Packing: 48pcs/ctn, 40.5X25.5X25.5 cm,  
 G.W.13kg, N.W.12kg

**Usage:**

Cold compress: put the cold/hot bag into freezer to be refrigerated for half an hour before taking out for use.

Hot compress: put the cold/hot bag into microwave oven to be warmed for 100 seconds for each time, and for 60 seconds when be used continuously.

**Purpose:**

Cold compress: physical therapy for traumatic hemorrhage, heatstroke, itch, headache, strain, scald, fatigue.

Hot compress: alleviate rheumatic pain, neural pain, sciatica, vertebral pain, improve mucous membrane scar after surgery.

**Precaution:**

The ice bag can only be used for external medication. If eye or skin should contact the content, it must be washed by clean water thoroughly. If one eats the content by mistake, he must drink enough water, try his best to vomit it and turn to doctor when necessary.

In order to avoid a too low or a too high temperature, it should be better to enwrap the cold/hot bag with a towel or cotton cloth to begin with. Those who have something wrong with their circulation system should refer to doctor in advance.

**Characteristic:**

This product can either be used for cold and for hot with a simple usage. The bag remains soft even in -18°C condition, and can be repeatedly used alternately for hot and for cold.



**GT105-100 Air Cushion**

Item: Air Cushion  
 Material: Calcium carbonate + 30% rubber  
 Description:  

φ 35cm	1pc/ 1 PE bag	20pcs/ctn	37X37X13cm
φ 40cm	1pc/ 1 PE bag	20pcs/ctn	42X42X15cm
φ 42.5cm	1pc/ 1 PE bag	20pcs/ctn	45X45X16cm
φ 45cm	1pc/ 1 PE bag	20pcs/ctn	47X47X17cm



**GT106-100 Ear Syringe**

Item: Ear Syringe  
 Material: Calcium carbonate + 25% rubber  
 Description:  

30ml	1pc/ 1 PE bag	600pcs/ctn	37X34X40cm
60ml	1pc/ 1 PE bag	600pcs/ctn	64X34X40cm
90ml	1pc/ 1 PE bag	360pcs/ctn	55X34X40cm



**GT107-100 Breast Reliever**

Item: Breast Reliever  
 Material: PVC + 25% rubber  
 Packing: 1pc/1 bag,  
 144pcs/ctn, 63X47X48 cm



**GT108-100 Vaginal Syringe**

Item: Vaginal syringe  
 Material: Calcium carbonate + 25% rubber  
 Description: 180G,  
 Packing: 1pc/ 1 PE bag,  
 120pcs/ctn, 51X50X40 cm



**GT109-100 Pear Shape Syringe**

Item: Pear Shape Syringe  
 Material: Calcium carbonate + 25% rubber  
 Description:  

30g	1pc/ 1 PE bag	360pcs/ctn	60X25X25cm
60g	1pc/ 1 PE bag	360pcs/ctn	80X32X31cm
90g	1pc/ 1 PE bag	360pcs/ctn	89X38X39cm
120g	1pc/ 1 PE bag	240pcs/ctn	75X40X35cm
150g	1pc/ 1 PE bag	240pcs/ctn	75X40X38cm
180g	1pc/ 1 PE bag	240pcs/ctn	82X48X39cm

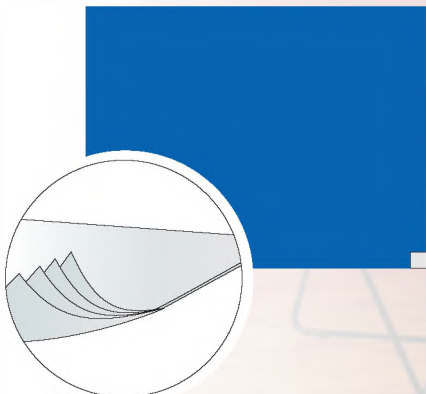

**GT700-102 Sterilizing Adhesive Mat**

Type: with Iodophor or without Iodophor  
 Film Material ----- Low density polyethylene  
 Adhesive Material ----- Water-based acrylic with iodine  
 Film Thickness ----- 50 μ m  
 Adhesive Thickness ----- 8 μ m  
 Tensile Strength ----- > 1.2kg/cm  
 Layer/Mat ----- 30 layers  
 Tackiness ----- High  
 Color ----- Deep Green  
 Packing ----- 10 mats/case  
 IODINE Content ----- 2g/m2  
 30-ply of material coated with adhesive that impregnated with or without iodophor P.V.P.  
 Sizes: 60cm X 90cm, 30-ply/pc 10pcs/61x91x40cm  
 65cm X 115cm, 30-ply/pc 10pcs/66x116x40cm

**Material:** PP

**Description:** This product is a scleroid plastic container which is used for collecting the needles of the syringes, infusion sets and pointed instruments like blades, scalp vein sets, suture needle, small glass products, etc. This product is for single use and the medical waste put in it is not allowed to be taken out and must be recycled by the waste disposable unit of the hospital, and then safely and completely burned within 48 hours. The product has the characteristics of non-toxic, safe, cast-resistant, and non-leaky.



**GT163-101**  
Capacity: 0.8L  
Product Size:  
Top Dia: 125mm,  
Bottom Dia: 95mm,  
Height: 115mm  
Carton Size: 510 x 390 x 570 mm  
Quantity in one Carton : 180pcs



**GT163-102**  
Capacity: 3.0L  
Product Size:  
Top Dia: 170mm,  
Bottom Dia: 150mm,  
Height: 150mm  
Carton Size: 520 x 520 x 460 mm  
Quantity in one Carton : 90pcs



**GT163-103**  
Capacity: 3.0L  
Product Size:  
Top Dia: 200mm,  
Bottom Dia: 160mm,  
Height: 140mm  
Carton Size: 620 x 340 x 450 mm  
Quantity in one Carton : 70pcs



**GT163-104**  
Capacity: 1.0L  
Product Size:  
Top Dia: 105mm,  
Bottom Dia: 80mm,  
Height: 185mm  
Carton Size: 340 x 320 x 400 mm  
Quantity in one Carton : 60pcs



**GT163-105**  
Capacity: 2.0L  
Product Size:  
Top Dia: 200mm,  
Bottom Dia: 120mm,  
Height: 170mm  
Carton Size: 405 x 270 x 450 mm  
Quantity in one Carton : 30pcs



**GT163-106**  
Capacity: 1.0L  
Product Size:  
Top Dia: 110mm,  
Bottom Dia: 90mm,  
Height: 160mm  
Carton Size: 360 x 320 x 460 mm  
Quantity in one Carton : 100pcs



**GT163-107**  
Capacity: 1.5L  
Product Size:  
Top Dia: 140mm,  
Bottom Dia: 110mm,  
Height: 160mm  
Carton Size: 400 x 320 x 445 mm  
Quantity in one Carton : 60pcs



**GT163-108**  
Capacity: 3.0L  
Product Size:  
Top Dia: 150mm,  
Bottom Dia: 120mm,  
Height: 260mm  
Carton Size: 480 x 320 x 480 mm  
Quantity in one Carton : 30pcs



**GT163-110**  
**Paper Safety box**  
75pcs/carton,  
62x30x258.5cm,  
20/18.5kgs

# Plastic Pill Box



## Pill Reminder TP7000

Material: ABS Size: 10.6x7.3x1.7cm

Description:

- 1) Large four compartments for pills
  - 2) Large six buttons for easy operation
  - 3) 24 hours alarm clock
  - 4) can set 4 group alarms per day as a reminder
  - 5) 4 group different alarm sound and easy-read LCD
- When the alarm time goes off, the different alarm sound and flashing symbol on LCD will remind a user of taking the pills from which compartment.
- 6) EL back light , good useful at night
- Packing: 200pcs/ctn, 69.5X21.5X43 cm



## GT164-002 new Plastic Pill Box

PS which is certified by FDA and Suggest 8.7 x 4.2 x 2.7cm, single polybag , MOQ is 5000pcs

## GT164-021

Size: 15.2 x 5.5 x 2.5cm

### Plastic Pill Box

PP plastic which is certified by FDA and SGS, single polybag ,MOQ is 5000pcs

## GT164-022

Size: 15.1 x 3.5 x 2.1 cm

### Plastic Pill Box

PP plastic which is certified by FDA and SGS, single polybag ,MOQ is 5000pcs

Other Medical Products

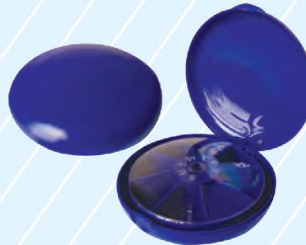

## GT164-022 new Plastic Pill Box

with magnet on the back of box, PP plastic which is certified by FDA and Suggest, 16.5 x 4.2 x 3.2cm, single polybag , MOQ is 5000pcs

## GT164-001 new Plastic Pill Box

ABS+PS which is certified by FDA and Suggest, 10 x 10 x 3.5cm, single polybag , MOQ is 5000pcs

## GT164-12 Plastic Pill Box

12 lattices, nontoxic PP, Size: 10 x 11.5 x 3cm, 65g



## GT164-026 new Plastic Pill Box

PP which is certified by FDA and Suggest 19 x 14 x 3.5cm, single polybag , MOQ is 5000pcs

## GT164-030

### Plastic Pill Box

PP which is certified by FDA and Suggest, 17.8 x 11 x 2.7cm, single polybag , MOQ is 5000pcs



**GT110-100 Feeding Bottle**

Item: Feeding Bottle  
 Description: 150ml,225ml,250ml,280ml  
 Material: PC、Liquid Silicone Nipple  
 Packing: 144pcs/ctn, 63X55X43 cm,  
 G.W.18kg, N.W.17kg

**GT110-200 Infant Nipple**

Item: Infant Nipple  
 Description: standard nipple  
 Material: Liquid Silicone Rubber  
 Packing: 240card/ctn, 57X43X30 cm,  
 G.W.7kg, N.W.6kg



**GT112-100 Disposable Umbilical Cord Clamp**

Usage: Clamp The Umbilical Cord Of Newborn Babies  
 Material:ABS,PE, PP  
 Color:Blue or White,Other Color By Optional  
 Size:5cm(European Market),5.5cm(Usa Market)  
 Packing: 1Pc/bag, 100Pcs/box,  
 50boxes/ 50 X 55 X 42cm, 18/17Kgs

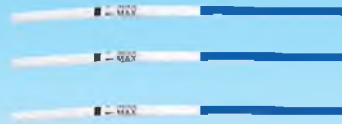

**GT111-100 HCG test strip**

2.5mm/3.0mm 25 mIU /ml  
 10000pcs/76x44x45cm



**GT111-200 HCG test devise**

3.0mm/3.5mm/4.0mm 25 mIU /ml  
 2500pcs/75x44x39cm

**GT111-300 HCG midstream**

4.0mm/4.5mm/6.0mm 25 mIU /ml  
 2000pcs/75x39x44cm



**GT112-200 Umbilical Cord Clamp Cutter**



**GT112-300 Umbilical Cutter A Packing**



**GT112-400 Amniotomy Hook**



**GT112-500 Endometrial suction curette**



### **GT128-100 Wooden Tongue Depressor**

Size Adult: 150mmx18mmx1.6mm  
 Sterile: Single Medical Paper Wrapped,  
 1pc/paper wrap, 100pcs/box  
 Non-sterile: 100pcs/box  
 5000pcs/ctn, Dimension: 47X36X31.5cm  
 Size Child: 140x14x1.6mm  
 Sterile: Single Medical Paper Wrapped,  
 1pc/paper wrap, 100pcs/box  
 Non-sterile: 100pcs/box  
 5000pcs/ctn, Dimension: 43X29X15.5cm

### **GT128-200 Plastic Tongue Depressor**

### **GT129-100 Cervical scraper (wooden)**

### **GT129-201 / GT129-202 Cervical scraper (Plastic)**

### **GT114-100: I.D.Bracelet**

Usage: Record Important Identification Information of A Patient,Tie On Patient's Wrist, 24-hour Close Identification Can Effectively Ensure That Any Time Quickly And Accurately Identify Patients.  
 Material:PVC  
 Color:Blue,Pink,White,Other Color By Optional  
 Model:Adhesive,Write-on,Insert-card,  
 With Hole(12,14,16) or Without Hole  
 Size:6",10",11",12"  
 Infant,Adult,Adult&Infant  
 Adult: 100Pcs/box 50boxes/56 X 42 X 26cm, 15/14Kgs  
 Infant: 100Pcs/box, 50boxes/42 X 36 X 26cm, 11/10Kgs  
 Adult&Infant: 50Pairs/box, 2500Paris/50 X 42 X 26.5, 13/12Kgs

### **GT113-100 Condom**

Surface: smooth, dotted, ribbed lubricated  
 Size: 49mm, 52mm, 55cm  
 Be available with spermicide nonoxynal  
 Be available with various fruit smell  
 If quantity is large enough, the condom is available with various color  
 Specification is available with En600, ISO4074, ASTM, WHO, SABS, etc.

# Vaginal Speculum

**Description:**

It can be used for the checking and treatment of gynecology disease in hospitals or clinics. Before using it, user must read the usage manual, and then take the speculum, push the "duckbill" of speculum that is closed into the vaginal slowly. Open the "duckbill" of speculum according to demand, fix the nut of speculum, then it can be used for checking and treatment of gynecology disease. After all, loose the nut of speculum, and take "duckbill" of speculum out of the vaginal slowly.

**Specification:**

Made of polystyrene;  
It is a transparent substance, non-toxic, medical grade  
Size: Large/Middle/Small  
Supplied sterile in individual polybag or Film+ Polybag or blister pack sterilized by ethylene oxide gas

**From of packing:**

steriled in individual polybag or Film+ Polybag or blister pack; 100pcs/ carton;

**Size of packing:**

Export carton:520x380x360mm

G.Weight.:7kgs

N.Weight: 6kgs

Other Medical Products



**GT159-100** Disposable Vaginal Speculum with side screw



**GT159-103** Disposable Vaginal Speculum with middle screw



**GT159-101** French type 1 Disposable Vaginal Speculum



**GT159-104** Australia type Disposable Vaginal Speculum



**GT159-102** Spanish type Disposable Vaginal Speculum



**GT159-105** South Asian type Disposable Vaginal Speculum



**GT207-P22 Cervical Rambrush**

Usage: Sampling Examination For Male And Female  
Material: Stainless Steel Thread + PVC Handle + Nylon Tip, PVC  
Model: Slid Type, Injection Type  
Packing: 1Pc/Pack, 100Packs/box, 50box/ 41 X 35 X 14cm, 13/12Kgs



# ECG Paper

- Single-lead ECG Paper
- 3-lead ECG Paper
- 6-lead ECG Paper
- 12-lead ECG Paper



**GT148-101  
ECG Paper**

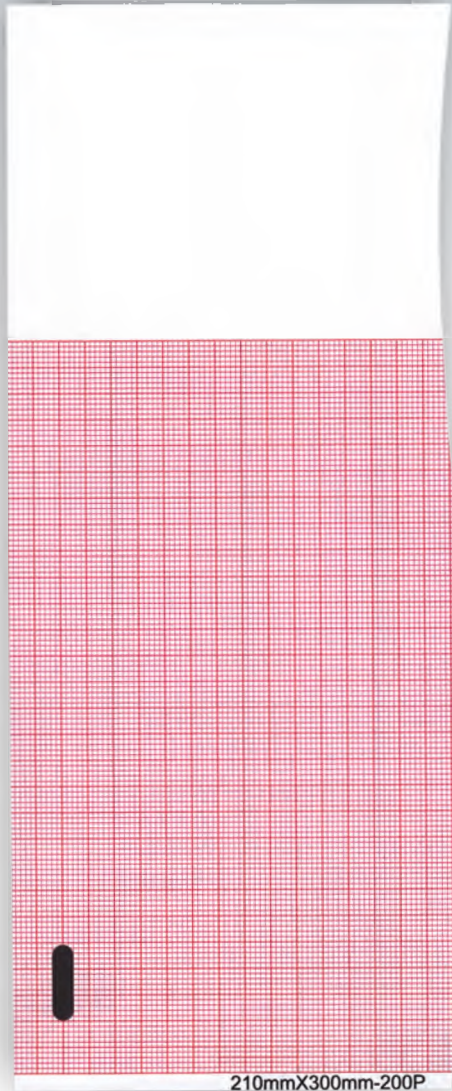

**12-lead ECG Paper**

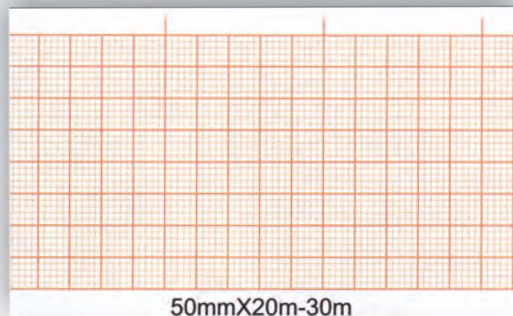

**Single-lead ECG Paper**



**6-lead ECG Paper**

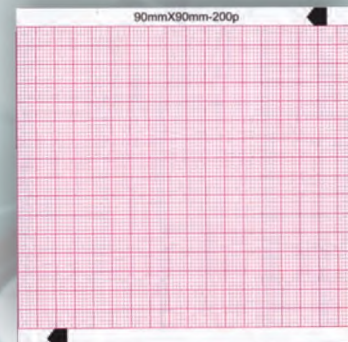

**3-lead ECG Paper**

- Single-lead ECG Paper: 50mm X 20m, 200pcs/ctn  
3-lead ECG Paper: 90mm X 90mm-200P, 100pcs/ctn  
6-lead ECG Paper: 112mm X 90mm-200P, 100pcs/ctn  
12-lead ECG Paper: 210mm X 300mm-200P, 20pcs/ctn



**GT170-100 Self-sealing flat pouch**

Size: 57x100mm	200pcs/box,	12000pcs/ctn,	27.6x37x30cm	13.5/12.5kgs
90x230mm	200pcs/box	4000pcs/ctn,	27.3x38.2x30cm	14.2/13.2kgs
135x255mm	200pcs/box	3000pcs/ctn,	29.8x40.4x30cm	17/16kgs
190x330mm	200pcs/box	2000pcs/ctn,	37.3x39.6x30cm	19.7/18.7kgs
250x370mm	200pcs/box	1000pcs/ctn,	26.3x41.3x30cm	15/14kgs



**GT170-101 Heat-sealing flat pouch**

Size: 57x130mm	200pcs/box	14400pcs/ctn	27.6x37x30cm	15.8/14.8kgs
90x230mm	200pcs/box	4800pcs/ctn	38.2x23.x30cm	16/15kgs
135x255mm	200pcs/box	3600pcs/ctn	26.8x42.4x30cm	18.1/17.1kgs
190x330mm	200pcs/box	2400pcs/ctn	34.3x29.6x30cm	21.5/20.5kgs
250x370mm	200pcs/box	1200pcs/ctn	38.3x26.3x30cm	16.4/15.4kgs

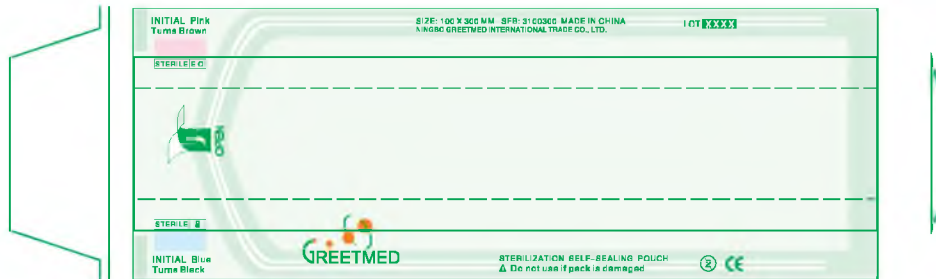

**GT170-102 Heat-sealing gusseted pouch**

Size: (75+25)x300mm	100pcs/box,	3000pcs/ctn,	31.3x40x30cm	12.12/11.12kgs
(100+50)x300mm	100pcs/box,	2400pcs/ctn,	31.3x42.2x30cm	12.8/11.8kgs
(150+50)x400mm	100pcs/box,	1200pcs/ctn,	41.3x31.6x30cm	12.8/11.8kgs
(200+55)x400mm	100pcs/box,	600pcs/ctn,	21.3x41.3x30cm	9.25/8.25kgs
(250+60)x450mm	100pcs/box,	600pcs/ctn,	26.3x46.3x30cm	12.15/11.15kgs



**GT170-103 Heat-sealing flat reel**

Size: 55mmx200m	1roll/box	6rolls/ctn	22.5x42x23cm	10.58/9.58kgs
75mmx200m	1roll/box	5rolls/ctn	22.5x46x23cm	11.75/10.75kgs
100mmx200m	1roll/box	4rolls/ctn	22.5x47x23cm	10/9kgs
150mmx200m	1roll/box	2rolls/ctn	22.5x34x23cm	9.8/8.8kgs
400mmx200m	non-box	1roll/ctn	22x41.5x22cm	12.4/11.4kgs

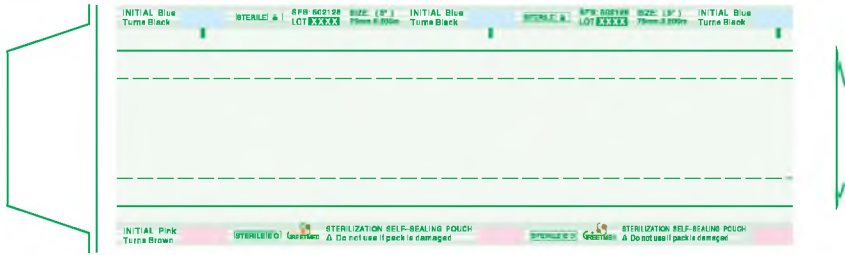

**GT170-104 Heat-sealing gusseted reel**

Size: (75mm+25mm)x100m	1 roll/box	5 rolls/ctn	22.5x46x23cm	8.75/7.75kgs
(100mm+50mm)x100m	1 roll/box	4 rolls/ctn	22.5x47x23cm	9.2/8.2kgs
(150mm+50mm)x100m	1 roll/box	2 rolls/ctn	22.5x34x23cm	7.4/6.4kgs
(400mm+75mm)x100m	non-box	1 roll/ctn	22x41x22cm	9.2/8.2kgs

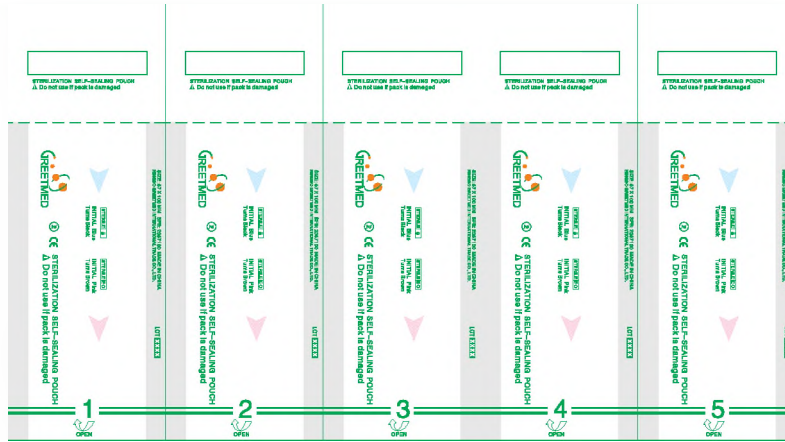

**GT170-105 Self-sealing connecting pouches**

Size: 38x92mm	200pcs/box, 4000pcs/ctn	39x26.6x30cm	14.5/13.5kgs
50x120mm	200pcs/box 3000pcs/ctn	26x47x58cm	15.1/14.1kgs



**GT170-106 Heat-sealing connecting pouches**

38x118mm	200pcs/box 4800pcs/ctn	24.6x39.6x30cm	12.98/11.98kgs
50x150mm	200pcs/box 3600pcs/ctn	26x47x30cm	16.2/15.2kgs

**GT171-100 Autoclave Indicator Tape, A.Characteristics**

1. Commodity: Autoclave Steam Tape,
2. Specification: Size Length And Width Are As Customer Request. Normally Size: 12.5mmx50m, 19mmx50m, 25mmx50mm Etc.
3. Backing Material: Good Quality Creped Paper
4. Color: Light Yellow
5. Adhesive: Acrylic Pressure Sensitive Adhesive
6. Characteris: 

Item	Unit	Standard
Adhesive Content	G/m2	115±5
180°C Peel	N/25mm	≧5
Time & Temperature	°Cmin	121°C ±3
Color Range		Light Yellow→ Black

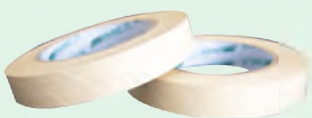



**Архангельск** (8182)63-90-72  
**Астана** (7172)727-132  
**Астрахань** (8512)99-46-04  
**Барнаул** (3852)73-04-60  
**Белгород** (4722)40-23-64  
**Брянск** (4832)59-03-52  
**Владивосток** (423)249-28-31  
**Волгоград** (844)278-03-48  
**Вологда** (8172)26-41-59  
**Воронеж** (473)204-51-73  
**Екатеринбург** (343)384-55-89  
**Иваново** (4932)77-34-06

**Ижевск** (3412)26-03-58  
**Иркутск** (395)279-98-46  
**Казань** (843)206-01-48  
**Калининград** (4012)72-03-81  
**Калуга** (4842)92-23-67  
**Кемерово** (3842)65-04-62  
**Киров** (8332)68-02-04  
**Краснодар** (861)203-40-90  
**Красноярск** (391)204-63-61  
**Курск** (4712)77-13-04  
**Липецк** (4742)52-20-81

**Магнитогорск** (3519)55-03-13  
**Москва** (495)268-04-70  
**Мурманск** (8152)59-64-93  
**Набережные Челны** (8552)20-53-41  
**Нижний Новгород** (831)429-08-12  
**Новокузнецк** (3843)20-46-81  
**Новосибирск** (383)227-86-73  
**Омск** (3812)21-46-40  
**Орел** (4862)44-53-42  
**Оренбург** (3532)37-68-04  
**Пенза** (8412)22-31-16

**Пермь** (342)205-81-47  
**Ростов-на-Дону** (863)308-18-15  
**Рязань** (4912)46-61-64  
**Самара** (846)206-03-16  
**Санкт-Петербург** (812)309-46-40  
**Саратов** (845)249-38-78  
**Севастополь** (8692)22-31-93  
**Симферополь** (3652)67-13-56  
**Смоленск** (4812)29-41-54  
**Сочи** (862)225-72-31  
**Ставрополь** (8652)20-65-13

**Сургут** (3462)77-98-35  
**Тверь** (4822)63-31-35  
**Томск** (3822)98-41-53  
**Тула** (4872)74-02-29  
**Тюмень** (3452)66-21-18  
**Ульяновск** (8422)24-23-59  
**Уфа** (347)229-48-12  
**Хабаровск** (4212)92-98-04  
**Челябинск** (351)202-03-61  
**Череповец** (8202)49-02-64  
**Ярославль** (4852)69-52-93

**Киргизия** (996)312-96-26-47

**Россия** (495)268-04-70

**Казахстан** (772)734-952-31